

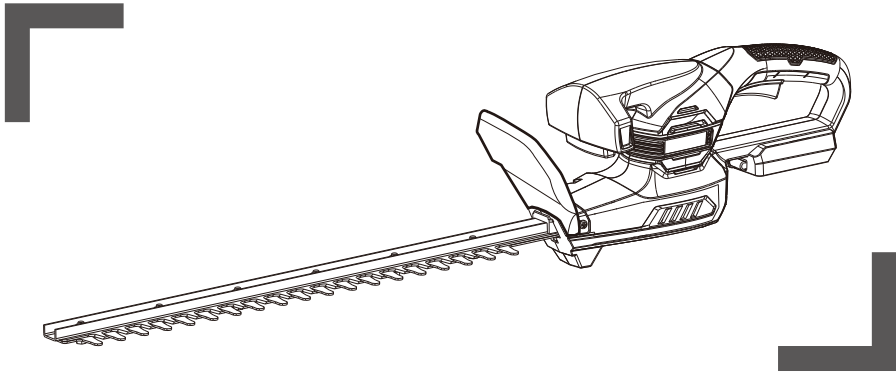

# Hedge Trimmer

## 18V 45cm



Original Instructions\_MNL\_NMHT18-Li\_GB\_V1\_210913

### NMHT18-Li



**BX220IM**

**CAUTION: Read the instructions before using the product.**

# Let's get started...

These instructions are for your safety. Please read through them thoroughly before use and retain them for future reference.



## Getting **started...** 02

<b>Safety</b> information	03
<b>Your</b> product	14
<b>Before</b> you <b>start</b>	15



## In more **detail...** 18

<b>Product</b> functions	18
<b>Operation</b>	19
<b>Care</b> and <b>maintenance</b>	21
<b>Troubleshooting</b>	23
<b>Recycling</b> and <b>disposal</b>	24
<b>Guarantee</b>	25
<b>Technical</b> specifications	27
<b>Declaration</b> of <b>conformity</b>	29

## Safety warnings

### General power tool safety warnings



**WARNING!** Read all safety warnings, instructions, illustrations and specifications provided with this power tool. *Failure to follow all instructions listed below may result in electric shock, fire and/or serious injury.*

**Save all warnings and instructions for future reference.**

*The term “power tool” in the warnings refers to your mains-operated (corded) power tool or battery-operated (cordless) power tool.*

Getting started...

### Work area safety

1. **Keep work area clean and well lit.** *Cluttered or dark areas invite accidents.*
2. **Do not operate power tools in explosive atmospheres, such as in the presence of flammable liquids, gases or dust.** *Power tools create sparks which may ignite the dust or fumes.*
3. **Keep children and bystanders away while operating a power tool.** *Distractions can cause you to lose control.*

### Electrical safety

1. **Power tool plugs must match the outlet. Never modify the plug in any way. Do not use any adapter plugs with earthed (grounded) power tools.** *Unmodified plugs and matching outlets will reduce risk of electric shock.*

## Safety warnings

2. **Avoid body contact with earthed or grounded surfaces, such as pipes, radiators, ranges and refrigerators.** *There is an increased risk of electric shock if your body is earthed or grounded.*
3. **Do not expose power tools to rain or wet conditions.** *Water entering a power tool will increase the risk of electric shock.*
4. **Do not abuse the cord. Never use the cord for carrying, pulling or unplugging the power tool. Keep cord away from heat, oil, sharp edges or moving parts.** *Damaged or entangled cords increase the risk of electric shock.*
5. **When operating a power tool outdoors, use an extension cord suitable for outdoor use.** *Use of a cord suitable for outdoor use reduces the risk of electric shock.*
6. **If operating a power tool in a damp location is unavoidable, use a residual current device (RCD) protected supply.** *Use of an RCD reduces the risk of electric shock.*

## Personal safety

1. **Stay alert, watch what you are doing and use common sense when operating a power tool. Do not use a power tool while you are tired or under the influence of drugs, alcohol or medication.** *A moment of inattention while operating power tools may result in serious personal injury.*
2. **Use personal protective equipment. Always wear eye protection.** *Protective equipment such as dust mask, non-skid safety shoes, hard hat, or hearing protection used for appropriate conditions will reduce personal injuries.*

3. **Prevent unintentional starting. Ensure the switch is in the off-position before connecting to power source, picking up or carrying the tool.** *Carrying power tools with your finger on the switch or energising power tools that have the switch on invites accidents.*
4. **Remove any adjusting key or wrench before turning the power tool on.** *A wrench or a key left attached to a rotating part of the power tool may result in personal injury.*
5. **Do not overreach. Keep proper footing and balance at all times.** *This enables better control of the power tool in unexpected situations.*
6. **Dress properly. Do not wear loose clothing or jewellery. Keep your hair and clothing away from moving parts.** *Loose clothes, jewellery or long hair can be caught in moving parts.*
7. **If devices are provided for the connection of dust extraction and collection facilities, ensure these are connected and properly used.** *Use of dust collection can reduce dust-related hazards.*
8. **Do not let familiarity gained from frequent use of tools allow you to become complacent and ignore tool safety principles.** *A careless action can cause severe injury within a fraction of a second.*

### **Power tool use and care**

1. **Do not force the power tool. Use the correct power tool for your application.** *The correct power tool will do the job better and safer at the rate for which it was designed.*
2. **Do not use the power tool if the switch does not turn it on and off.** *Any power tool that cannot be controlled with the switch is dangerous and must be repaired.*

## Safety warnings

- 3. Disconnect the plug from the power source and/ or remove the battery pack, if detachable, from the power tool before making any adjustments, changing accessories, or storing power tools.** *Such preventive safety measures reduce the risk of starting the power tool accidentally.*
- 4. Store idle power tools out of the reach of children and do not allow persons unfamiliar with the power tool or these instructions to operate the power tool.** *Power tools are dangerous in the hands of untrained users.*
- 5. Maintain power tools. Check for misalignment or binding of moving parts, breakage of parts and any other condition that may affect the power tool's operation. If damaged, have the power tool repaired before use.** *Many accidents are caused by poorly maintained power tools.*
- 6. Keep cutting tools sharp and clean.** *Properly maintained cutting tools with sharp cutting edges are less likely to bind and are easier to control.*
- 7. Use the power tool, accessories and tool bits etc. in accordance with these instructions, taking into account the working conditions and the work to be performed.** *Use of the power tool for operations different from those intended could result in a hazardous situation.*
- 8. Keep handles and grasping surfaces dry, clean and free from oil and grease.** *Slippery handles and grasping surfaces do not allow for safe handling and control of the tool in unexpected situations.*

## Battery tool use and care

1. **Recharge only with the charger specified by the manufacturer.** *A charger that is suitable for one type of battery pack may create a risk of fire when used with another battery pack.*
2. **Use power tools only with specifically designated battery packs.** *Use of any other battery packs may create a risk of injury and fire.*
3. **When battery pack is not in use, keep it away from other metal objects, like paper clips, coins, keys, nails, screws or other small metal objects that can make a connection from one terminal to another.** *Shorting the battery terminals together may cause burns or a fire.*
4. **Under abusive conditions, liquid may be ejected from the battery; avoid contact. If contact accidentally occurs, flush with water. If liquid contacts eyes, additionally seek medical help.** *Liquid ejected from the battery may cause irritation or burns.*
5. **Do not use battery pack or tool that is damaged or modified.** *Damaged or modified batteries may exhibit unpredictable behaviour resulting in fire, explosion or risk of injury.*
6. **Do not expose a battery pack or tool to fire or excessive temperature.** *Exposure to fire or temperature above 130 °C may cause explosion.*
7. **Follow all charging instructions and do not charge the battery pack or tool outside the temperature range specified in the instructions.** *Charging improperly or at temperatures outside the specified range may damage the battery and increase the risk of fire.*

Getting started...

## Safety warnings

### Service

1. **Have your power tools serviced by a qualified repair person using only identical replacement parts.** *This will ensure that safety of the power tool is maintained.*
2. **Never service damaged battery packs.** *Service of battery packs should only be performed by the manufacturer or authorized service providers.*

### Hedge trimmer safety warnings:

1. **Keep all parts of the body away from the blade. Do not remove cut material or hold material to be cut when blades are moving.** *Blades continue to move after the switch is turned off. A moment of inattention while operating the hedge trimmer may result in serious personal injury.*
2. **Carry the hedge trimmer by the handle with the blade stopped and taking care not to operate any power switch.** *Proper carrying of the hedge trimmer will decrease the risk of inadvertent starting and resultant personal injury from the blades.*
3. **When transporting or storing the hedge trimmer, always fit the blade cover.** *Proper handling of the hedge trimmer will decrease the risk of personal injury from the blades.*
4. **When clearing jammed material or servicing the unit, make sure all power switches are off and the power cord is disconnected.** *Unexpected actuation of the hedge trimmer while clearing jammed material or servicing may result in serious personal injury.*



5. **Hold the hedge trimmer by insulated gripping surfaces only, because the blade may contact hidden wiring or its own cord.** *Blades contacting a "live" wire may make exposed metal parts of the hedge trimmer "live" and could give the operator an electric shock.*
6. **Keep all power cords and cables away from cutting area.** *Power cords or cables may be hidden in hedges or bushes and can be accidentally cut by the blade.*
7. **Do not use the hedge trimmer in bad weather conditions, especially when there is a risk of lightning.** *This decreases the risk of being struck by lightning.*

#### **Additional safety warnings for battery pack**

1. **Battery pack needs to be charged before use.** *Always refer to the charger's instruction and charge it properly.*
2. **Remove the battery pack from the product when not in use.**
3. **Don't maintain the battery pack on the charger when not in use.**
4. **After extended periods of storage, it may be necessary to charge and discharge the battery pack several times to obtain the maximum performance.**
5. **Longer life and better performance can be obtained if the battery is charged when the air temperature is between 18°C and 24°C.** *Do not charge the battery in air temperature below 5°C or above 40°C. This is important as it can prevent serious damage to the battery.*
6. **Do not charge battery in a damp or wet location.** *Following this rule will reduce the risk of electric shock.*

## Safety warnings

7. **Do not disassemble the battery and avoid mechanical damage to the battery. Risk of short circuit and fumes may be emitted.** *Ensure fresh air and seek medical assistance in the event of discomfort.*
8. **When disposing of battery pack, keep the battery pack of different electrochemical systems separate from each other.**

### Vibration and noise reduction

**To reduce the impact of noise and vibration emission, limit the time of operation, use low-vibration and low-noise operating modes as well as wear personal protective equipment.**

Take the following points into account to minimise the vibration and noise exposure risks:

1. Only use the product as intended by its design and these instructions.
2. Ensure that the product is in good condition and well maintained.
3. Use correct attachments for the product and ensure they are in good condition.
4. Keep tight grip on the handles/grip surface.
5. Maintain this product in accordance with these instructions and keep it well lubricated (where appropriate).
6. Plan your work schedule to spread any high vibration tool use across a longer period of time.
7. Prolonged use of the product exposes the user to vibrations that can cause a range of conditions collectively known as hand-arm vibration syndrome (HAVS) e.g. fingers going white; as well as specific diseases such as carpal tunnel syndrome. To reduce this risk when using the product, always wear protective gloves and keep your hands warm.

## Emergency

Familiarise yourself with the use of this product by means of this instruction manual. Memorise the safety directions and follow them to the letter. This will help to prevent risks and hazards.

1. **Always be alert when using this product, so that you can recognise and handle risks early.** *Fast intervention can prevent serious injury and damage to property.*
2. **Switch the product off and remove the battery pack if there are malfunctions.** *Have the product checked by a qualified professional and repaired, if necessary, before you operate it again.*

## Residual risks

Even if you are operating this product in accordance with all the safety requirements, potential risks of injury and damage remain. The following dangers can arise in connection with the structure and design of this product:

1. Health defects resulting from vibration emission if the product is being used over long periods of time or not adequately managed and properly maintained.
2. Injuries and damage to property due to broken attachments or the sudden impact of hidden objects during use.
3. Danger of injury and property damage caused by flying objects.



**WARNING!** This product produces an electromagnetic field during operation! This field may under some circumstances interfere with active or passive medical implants! To reduce the risk of serious or fatal injury, we recommend persons with medical implants to consult their doctor and the medical implant manufacturer before operating this product!

## Symbols

On the product, the rating label and within these instructions you will find among others the following symbols and abbreviations. Familiarise yourself with them to reduce hazards like personal injuries and damage to property.

V 	Volt, (direct current voltage)	mAh	Milliampere per hour
/min or min <sup>-1</sup>	Per minute	°C	Degree Celsius
g	Gram	kg	Kilogram
mm	Millimetre	m	Metre
cm	Centimeter	m/s <sup>2</sup>	Metres per second squared
dB(A)	Decibel (A-rated)		



Lock / to tighten or secure.



Unlock / to loosen.



Read the instruction manual.



Note / Remark.



Caution / Warning.

xxWyy

Manufacturing date code; year of manufacturing (20xx) and week of manufacturing (Wyy)



Wear hearing protection.



Wear eye protection.



Wear a dust mask.



Wear protective gloves.



Wear protective, slip-resistant footwear.



Wear tight-fitted protective clothes.



Switch the product off and remove battery pack before assembly, cleaning, adjustments, maintenance, storage and transportation.



This product is of protection class III.



Do not expose the product to rain or wet conditions (moisture).



Keep hands away from moving cutting device!



Objects thrown by the product could hit the user or other bystanders. Always ensure that other people and pets remain at a safe distance from the product when it is in operation. In general, children must not come near the area where the product is.



Guaranteed sound power level value in 96 dB.



WEEE symbol. Waste electrical products should not be disposed of with household waste. Please recycle where facilities exist. Check with your Local Authority or local store for recycling advice.



Crossed out dust bin. Batteries and battery packs should not be disposed of with household waste. Please recycle where facilities exist. Check with your Local Authority or local store for recycling advice.



Do not dispose of battery packs in rivers or immerse in water.



Do not dispose of battery packs in fire. They will explode and cause injury.



Do not expose battery packs to heat in excess of 40 °C. Do not charge or store the battery pack in temperatures below 5 °C (41 °F) and above 40 °C (104°F).



The product complies with the applicable European directives and an evaluation method of conformity for these directives was done. UK Conformity Assessed.

## Your product

Getting started...

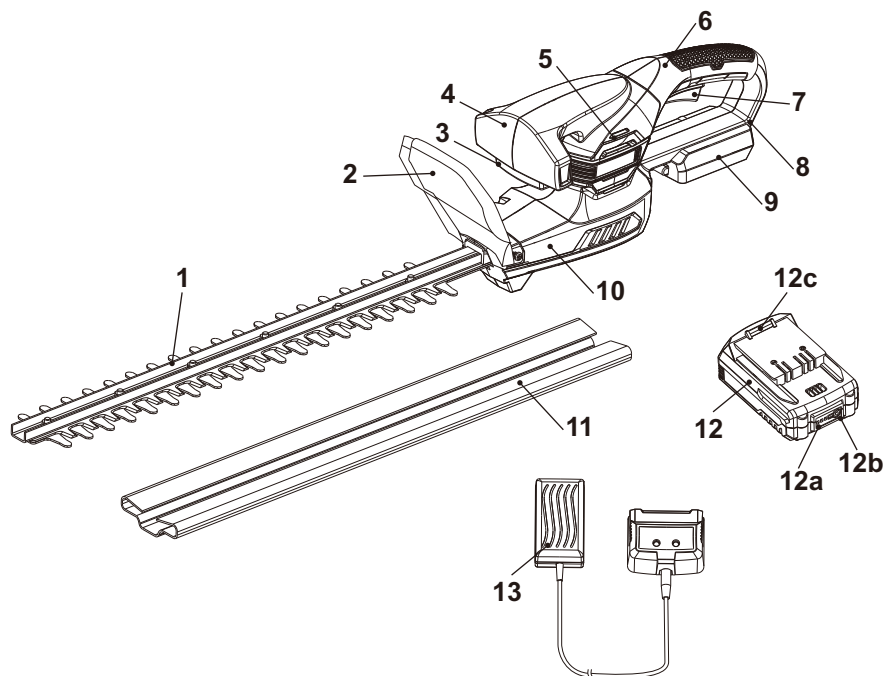

- |                           |                                |
|---------------------------|--------------------------------|
| 1. Cutting device (blade) | 9. Battery docking port        |
| 2. Front safeguard        | 10. Housing                    |
| 3. Safety switch          | 11. Blade cover                |
| 4. Front handle           | 12. Battery pack               |
| 5. Air vents              | a. Battery capacity indicators |
| 6. Rear handle            | b. Battery capacity button     |
| 7. On/off switch          | c. Release button              |
| 8. Rear safeguard         | 13. Charger                    |



**NOTE:** Parts marked with \* are not shown in this overview. Please refer to the respective part in the instruction manual.

## Unpacking

1. Unpack all parts and lay them on a flat, stable surface.
2. Remove all packing materials and shipping devices if applicable.
3. Make sure the delivery contents are complete and free of any damage. If you find that parts are missing or show damage do not use the product but contact your dealer. Using an incomplete or damaged product represents a hazard to people and property.
4. Ensure that you have all the accessories and tools needed for assembly and operation. This also includes suitable personal protective equipment.



**WARNING!** The product and the packaging are not children's toys! Children must not play with plastic bags, sheets and small parts! There is a danger of choking and suffocation!

## You will need

### (items not supplied)

Suitable personal protective equipment  
 Suitable cross-head driver  
 Lubricant for blade

### (items supplied)

Blade cover (11)  
 Battery pack (12)  
 Charger (13) and its manual



**NOTE:** The accessories required depend on the intended application. Ask your dealer for advice.

## Setup



**WARNING!** Before using the product, familiarise yourself with the operating features read the entire instruction manual paying particular attention to the safety rules and operating procedures. Do not connect the product to battery pack (12) before it is completely assembled!

## Setup

### Front safeguard

The front safeguard (2) is already pre-installed on the housing (10) (Fig. 1).

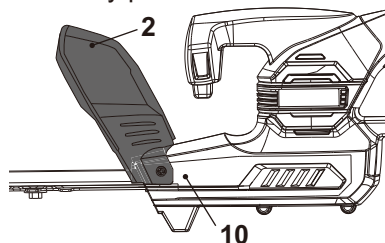

Fig. 1

### Blade cover

1. Remove the blade cover (11) from the cutting device (blade) (1) before operation (Fig. 2).
2. Keep the blade cover (11) safely.

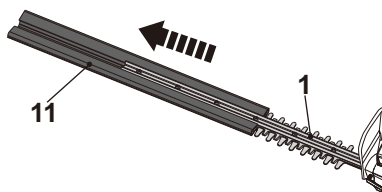

Fig. 2



**NOTE:** Always attach the blade cover (11) when the product is not in use, for storage and transportation.

To attach the blade cover (11), align and push the blade cover onto the cutting device (blade) (1).

## Battery pack

### Attaching / releasing the battery pack

1. Align the battery pack (12) with the sliding slots of the battery docking port (9) under the rear safeguard (8) and slide the battery pack (12) in to attach it. Ensure it clicks in place (Fig. 3).
2. Press the release button (12c) and remove the battery pack (12) from the battery docking port (9) (Fig. 4).



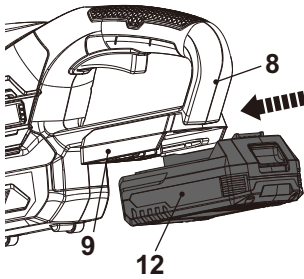

Fig. 3

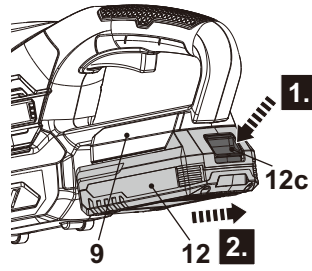

Fig. 4

### Charging the battery pack

The battery pack (12) for this product has been shipped in a low charge condition. Charge it fully before first use.

Refer to the charger's instruction manual (**NMC18**) for the details.

### Battery capacity indicators

The battery pack (12) is equipped with the battery capacity indicators (12a) which are used to give an indication of the battery pack's remaining capacity. Press the battery capacity button (12b) to check battery capacity (Fig. 5).

The LEDs will stay lit for approximately 2 seconds.

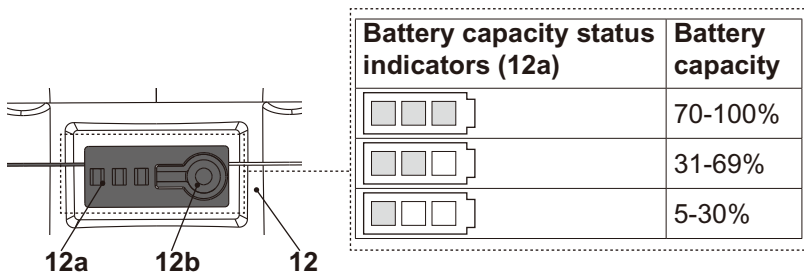

Fig. 5

Getting started...

## Intended use

This cordless hedge trimmer NMHT18-Li is designated with a rated voltage of 18 V $\overline{\text{---}}$ . It is designed only to be used with the battery pack which is listed in the chapter of "Technical specifications".

The product is intended for cutting and trimming of hedges, bushes and shrubs in domestic gardens. The maximum cutting capacity must be observed. Do not cut branches exceeding the stated maximum capacity.

The use of this product in case of rain or humid environment is prohibited.

For safety reasons it is essential to read the entire instruction manual before first operation and to observe all the instructions therein.

This product is intended for private domestic use only, not for any commercial trade use. It must not be used for any purposes other than those described.

## Switching on/off

1. Ensure the cutting device (blade) (1) does not touch any objects. Remove the blade cover (11) from the cutting device (blade) (1) before switching the product on.
2. Hold the product with one hand on the front handle (4) and the other hand on the rear handle (6).
3. Squeeze the safety switch (3) and hold it in position (Fig. 6, step 1).
4. Squeeze the on/off switch (7) to switch the product on (Fig. 6, step 2).
5. Release either the on/off switch (7) or the safety switch (3) to switch the product off.

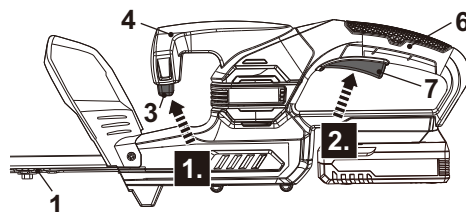

Fig. 6

## General operation

1. Check the product, its battery pack and charger as well as accessories for damage before each use. Do not use the product if it is damaged or shows wear. Take care of any problem you find or have the product checked by qualified specialist.
2. Double check that the accessories and attachments are properly fixed.
3. Always hold the product on its handles. Keep the handles dry to ensure safe support.
4. Ensure that the air vents are always unobstructed and clear. Clean them if necessary with a soft brush. Blocked air vents may lead to overheating and damage the product.
5. Switch the product off immediately if you are disturbed while working by other people entering the working area. Always let the product come to complete stop before putting it down.
6. Do not overwork yourself. Take regular breaks to ensure you can concentrate on the work and have full control over the product.

## Trimming times

green leaf hedges	June to October
evergreens	April and August
conifers and other fast growing shrubs	every 6 - 8 weeks

## Trimming



**NOTE:** Try to keep the cutting device angled at approximately 15° to the cutting surface.

1. Make sure that the blade cover (11) is removed, and the battery pack (12) is assembled before operation.
2. Ensure that no people or animals are in the work area.
3. Cut and remove branches exceeding the cutting capacity of this product using a proper pruner before operation.
4. Always hold the product firmly with both hands on front handle (4) and rear handle (6). Never operate this product using only one hand.
5. Do not rush and do not attempt to cut too much with one stroke of the cutting device.

In more detail...

## Trimming

6. First cutting both sides from the bottom upwards to the top. This will prevent any of the cuttings falling into the path of the area still to be cut (Fig. 7).
7. After cutting the sides proceed to the top. Try to keep the cutting device angled at approximately  $15^\circ$  to the cutting surface (Fig. 8).

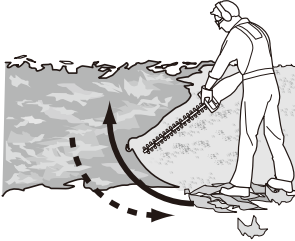

Fig. 7

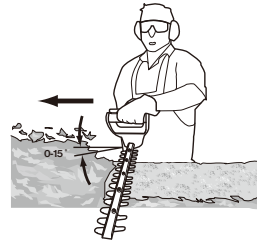

Fig. 8

8. When cutting wide hedges with the cutting area in sight move the cutting blade lightly through the cutting surface in a sweeping motion following the shape of the hedge or shrub. A slight tilt downwards of the cutting blade in the direction of motion is recommended for optimum cutting performance.
9. Cut in a number of stages to achieve a better result rather than trying to cut in one go if the area being cut is particularly long (Fig. 9); smaller cuttings will allow for easy composting.



**NOTE:** When shaping it is advisable to achieve a trapezoidal shape (Fig. 10). A trapezoidal cut corresponds to the natural growth of plants and results in optimal hedge growth, as it will expose more light to the lower end of the hedge.

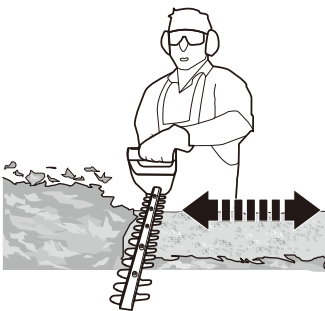

Fig. 9

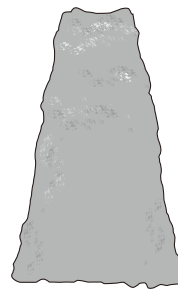

Fig. 10

10. Lubricate the internal surfaces of the blade if the cutting device (blade) (1) overheats during operation (Fig. 11).



**WARNING!** This operation must only be performed when the blades have stopped running and the product is switched off!

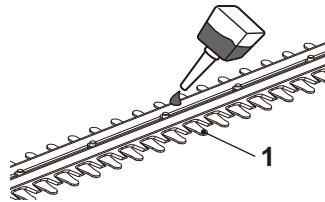

Fig. 11

## After use

1. Switch the product off, remove the battery back and let it cool down.
2. Attach the blade cover (11) if necessary.
3. Check, clean and store the product as described below.

## The golden rules for care



**WARNING!** Always switch the product off, remove the battery pack (12) and let the product cool down before performing inspection, maintenance and cleaning work!

1. Keep the product clean. Remove debris from it after each use and before storage.
2. Regular and proper cleaning will help ensure safe use and prolong the life of the product.
3. Inspect the product before each use for worn and damaged parts. Do not operate it if you find broken and worn parts.



**WARNING!** Only perform repairs and maintenance work according to these instructions! All further works must be performed by a qualified specialist!

In more detail...

## General Cleaning

1. Clean the product with a damp cloth and pH-neutral soap. Use a brush for areas that are hard to reach.
2. In particular clean the air vents (5) after every use with a cloth and brush.
3. Remove stubborn dust with high pressure air (max. 3 bar).



**NOTE:** Do not use chemical, alkaline, abrasive or other aggressive detergents or disinfectants to clean this product as they might be harmful to its surfaces.

4. Check for any damage and wear. Repair damages in accordance with this instruction manual or take it to an authorised service centre before using the product again.

## Cutting device (blade)



**WARNING!** Wear safety gloves when working on the cutting device and close to it! Use appropriate tools to remove debris, e. g. a brush or wooden stick! Never use your bare hands!



1. Keep the cutting device (blade) (1) clean and free of debris. Remove trimmings with a brush.
2. Apply a small amount of suitable lubricant on the cutting device (blade) to retain a good cutting performance (Fig. 11).

## Repair

This product does not contain any parts that can be repaired by the consumer. Contact an authorised service centre or a similarly qualified person to have it checked and repaired.

## Storage

1. Switch the product off and remove the battery pack.
2. Clean the product as described above.
3. Attach the blade cover (11) onto the cutting device (blade) (1).
4. Store the product and its accessories in a dark, dry, frost-free, well-ventilated place.

5. Always store the product in a place that is inaccessible to children. The ideal storage temperature is between 10 °C and 30 °C.
6. We recommend using the original package for storage or covering the product with a suitable cloth or enclosure to protect it against dust.

## Transportation

1. Switch the product off remove the battery pack.
2. Attach the blade cover (11) onto the cutting device (blade) (1).
3. Always carry the product by its handles (4, 6).
4. Protect the product from any heavy impact or strong vibrations which may occur during transportation in vehicles.
5. Secure the product to prevent it from slipping or falling over.

## Troubleshooting

Suspected malfunctions are often due to causes that the users can fix themselves. Therefore check the product using this section. In most cases the problem can be solved quickly.



**WARNING!** Only perform the steps described within these instructions! All further inspection, maintenance and repair work must be performed by an authorised service centre or a similarly qualified specialist if you cannot solve the problem yourself!

Problem	Possible cause	Solution
1. Product does not start	1.1 Battery pack is not properly attached 1.2 Battery pack is discharged 1.3 Battery pack is damaged 1.4 Other electrical defect to the product	1.1 Attach properly 1.2 Remove and charge battery pack 1.3 Check by a specialist electrician 1.4 Check by a specialist electrician
2. Product does not reach full power	2.1 Battery pack capacity is too low 2.2 Air vents are blocked	2.1 Charge battery pack 2.2 Clean the air vents
3. Unsatisfactory cutting result	3.1 Blade is worn / damaged 3.2 Thickness of branches exceeds capacity	3.1 Replace with a new one 3.2 Only cut branches complying with the capacity

In more detail...

## Troubleshooting

Problem	Possible cause	Solution
4. Product suddenly stops	4.1 Battery pack is discharged	4.1 Remove and charge battery pack
	4.2 Battery pack is too hot	4.2 Remove battery pack and let it cool down
	4.3 Cutting device is blocked	4.3 Remove blockage
5. Excessive vibration or noise	5.1 Blade is dull/damaged	5.1 Replace with a new one
	5.2 Bolts/nuts are loosen	5.2 Tighten bolts/nuts

## Recycling and disposal



Waste electrical products should not be disposed of with household waste. Please recycle where facilities exist. Check with your Local Authority or local store for recycling advice.

**For further information visit [www.recycle-more.co.uk](http://www.recycle-more.co.uk).**

The product comes in a package that protects it against damage during shipping. Keep the package until you are sure that all parts have been delivered and the product is working properly. Recycle the package afterwards.

### Disposal of an exhausted battery pack



The battery is Li-Ion type. To preserve natural resources, please recycle or dispose of the battery pack properly. Consult your local waste authority for information regarding available recycling and / or disposal options.

Discharge your battery pack by operating your tool, then remove the battery pack from the tool and cover the battery pack connections with heavy duty adhesive tape to prevent short circuit and energy discharge.

Do not attempt to open or remove any of the components.



## Guarantee

We take special care to select high quality materials and use manufacturing techniques that allow us to create products incorporating design and durability. This product has a manufacturer's guarantee of *2 years* against manufacturing defects, from the date of purchase (if bought in store) or date of delivery (if bought online), at no additional cost for normal (non-professional or commercial) household use.

To make a claim under this guarantee, you must present your proof of purchase (such as a sales receipt, purchase invoice or other evidence admissible under applicable law), please keep your proof of purchase in a safe place. For this guarantee to apply, the product you purchased must be new, it will not apply to second hand or display products. Unless stated otherwise by applicable law, any replacement product issued under this guarantee will only be guaranteed until expiry of the original period guarantee period.

This guarantee covers product failures and malfunctions provided the product was used for the purpose for which it is intended and subject to installation, cleaning, care and maintenance in accordance with the information contained in these terms and conditions, in the user manual and standard practice, provided that standard practice does not conflict with the user manual.

This guarantee does not cover defects and damage caused by normal wear and tear or damage that could be the result of improper use, faulty installation or assembly, neglect, accident, misuse, or modification of the product. Unless stated otherwise by applicable law, this guarantee will not cover, in any case, ancillary costs (shipping, movement, costs of uninstalling and reinstalling, labour etc), or direct and indirect damage.

Rights under this guarantee are enforceable in the country in which you purchased this product. Guarantee related queries should be addressed to the store you purchased this product from.

The guarantee is in addition to and does not affect your statutory rights.

### **Manufacturer:**

Kingfisher International Products Limited  
3 Sheldon Square, W26PX London United Kingdom  
[www.kingfisher.com/products](http://www.kingfisher.com/products)

In more detail...

## Guarantee

---

**Distributor:**

B&Q plc

Chandlers Ford, Hants, SO53 3LE, United Kingdom

[www.diy.com](http://www.diy.com)

Screwfix Direct Limited

Trade House, Mead Avenue, Yeovil, BA22 8RT, United Kingdom

[www.screwfix.com](http://www.screwfix.com)

In more detail...

## Technical specifications

### General

- > **Rated voltage** : 18V 
- > **Rated no load speed  $n_0$**  : 1200 min<sup>-1</sup>
- > **Blade length** : 45 cm
- > **Max. cutting length** : 41.8 cm
- > **Tooth gap** : max. 16 mm
- > **Protection class** : III
- > **Weight** : approx. 1.84 kg
- > **Dimensions** : approx. 160\*120\*820 mm

### Battery pack

- > **Model no.** : NMBA18-2
- > **Type** : Li-Ion, 5 x 3.6 V 
- > **Capacity** : 2000 mAh
- > **Voltage** : 18 V 
- > **Weight** : approx. 0.39 kg

### Charger for battery pack

- > **Model no.** : NMC18

### Sound values

- > **Sound pressure level  $L_{pA}$**  : 68 dB(A)
- > **Uncertainty  $K_{pA}$**  : 3 dB(A)
- > **Measured sound power level  $L_{WA}$**  : 84.5 dB(A)
- > **Guaranteed sound power level  $L_{WA}$**  : 96 dB(A)
- > **Uncertainty  $K_{WA}$**  : 2.07 dB(A)

### Hand arm vibration values

- > **Front handle  $a_{h,W}$**  :  $\leq 2.5$  m/s<sup>2</sup>
- > **Rear handle  $a_{h,W}$**  :  $\leq 2.5$  m/s<sup>2</sup>
- > **Uncertainty  $K$**  : 1.5 m/s<sup>2</sup>

The sound values have been determined according to noise test code given in EN 62841-4-2, using the basic standards EN ISO 11201 and EN ISO 3744.

The sound intensity level for the operator may exceed 80 dB(A) and ear protection measures are necessary.

The declared vibration value has been measured in accordance with a standard test method (according to EN 62841-4-2) and may be used for comparing one product with another. The declared vibration value may also be used in a preliminary assessment of exposure.

In more detail...

## Technical specifications



**WARNING!** Depending on the actual use of the product the vibration values can differ from the declared total. Adopt proper measures to protect yourself against vibration exposures. Take the whole work process including times the product is running under no load or switched off into consideration.

Proper measures include among others regular maintenance and care of the product and accessories, keeping hands warm, periodical breaks and proper planning of work processes.

## Rating label explanation

### Hedge trimmer: NMHT18-Li

NM = Brand name

HT = Hedge trimmer

18 = Rated voltage (V)

Li = Lithium-Ion

### Battery pack: NMBA18-2

NM = Brand name

BA= Battery

18 = Battery output voltage (V)

2 = Battery capacity (Ah)

### Charger: NMC18

NM = Brand name

C = Charger

18 = Battery output voltage (V)



# Declaration of conformity

---

In more detail...



**Manufacturer, Fabricant, Producent, Producător, Fabricante:**

**UK Manufacturer:**

Kingfisher International Products Limited  
3 Sheldon Square, London, W2 6PX  
United Kingdom  
[www.kingfisher.com/products](http://www.kingfisher.com/products)

**EU Manufacturer:**

Kingfisher International Products B.V.  
Rapenburgerstraat 175E  
1011 VM Amsterdam  
The Netherlands  
[www.kingfisher.com/products](http://www.kingfisher.com/products)

- |           |  |   |
|-----------|--|---|
| <b>EN</b> | <a href="http://www.diy.com">www.diy.com</a><br><a href="http://www.screwfix.com">www.screwfix.com</a><br><a href="http://www.screwfix.ie">www.screwfix.ie</a> | To view instruction manuals online, visit<br><a href="http://www.kingfisher.com/products">www.kingfisher.com/products</a>                                   |
| <b>FR</b> | <a href="http://www.castorama.fr">www.castorama.fr</a><br><a href="http://www.bricodepot.fr">www.bricodepot.fr</a>   | Pour consulter les manuels d'instructions en ligne,<br>rendez-vous sur le site <a href="http://www.kingfisher.com/products">www.kingfisher.com/products</a> |
| <b>PL</b> | <a href="http://www.castorama.pl">www.castorama.pl</a>   | Aby zapoznać się z instrukcją obsługi online, odwiedź<br>stronę <a href="http://www.kingfisher.com/products">www.kingfisher.com/products</a>                |
| <b>ES</b> | <a href="http://www.bricodepot.es">www.bricodepot.es</a>   | Para consultar los manuales de instrucciones en línea,<br>visite <a href="http://www.kingfisher.com/products">www.kingfisher.com/products</a>               |
| <b>PT</b> | <a href="http://www.bricodepot.pt">www.bricodepot.pt</a>   | Para consultar manuais de instruções online, visite<br><a href="http://www.kingfisher.com/products">www.kingfisher.com/products</a>                         |
| <b>RO</b> | <a href="http://www.bricodepot.ro">www.bricodepot.ro</a>   | Pentru a consulta manualele de instrucțiuni online, vizitați<br><a href="http://www.kingfisher.com/products">www.kingfisher.com/products</a>                |
| <b>TR</b> | <a href="http://www.koctas.com.tr">www.koctas.com.tr</a>   | Kullanım kılavuzuna internet üzerinden ulaşmak için<br><a href="http://www.kingfisher.com/products">www.kingfisher.com/products</a> adresini ziyaret edin   |