

TITAN

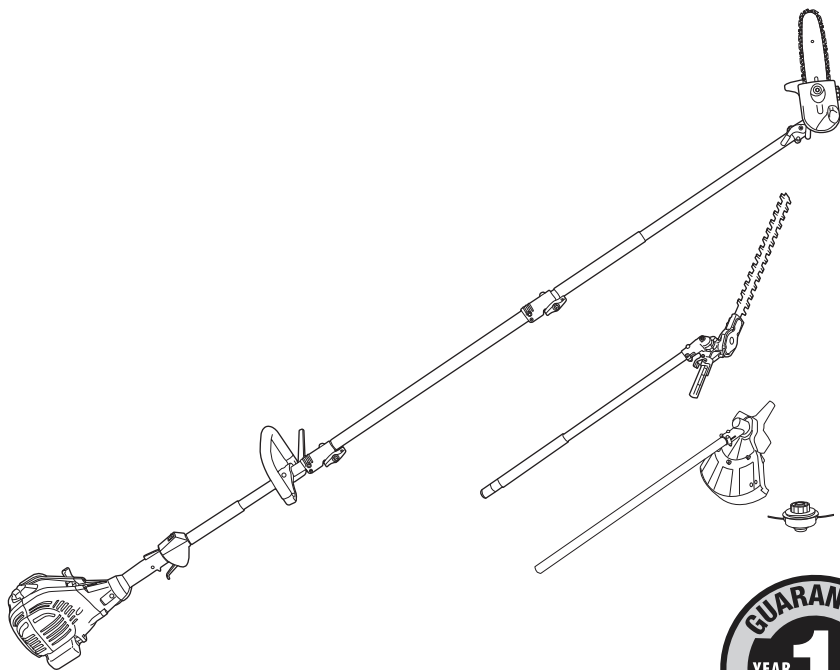

SAFETY AND OPERATING MANUAL

Should you experience any issues with this Titan product, please do not return it to Store.
Please contact the Titan 2 Stroke Helpline on: 0333 2000 339

Original Instructions
V130920 / BX220IM

25CC PETROL MULTI TOOL TTK587GDO

TITAN

Congratulations on your purchase of a **TITAN** power tool from Kingfisher International Products Limited. We want you to continue getting the best performance from it so this handbook includes information on safety, handling and care. Please retain this handbook in case you need to refer to any of the information in the future

Your **TITAN** power tool comes with a 1-year guarantee. Should it develop a fault within this period please do not return it to Store. Please contact the Titan 2 Stroke Helpline on: 0333 2000 339 in the first instance.

GUARANTEE

This **TITAN** product carries a guarantee of 1 year. If your product develops a fault within this period, you should, in the first instance contact: 0333 2000 339 (Mon – Fri : 09.00 – 17.00)

This guarantee specifically excludes losses caused due to:

- Fair wear and tear
- Misuse or abuse
- Lack of routine maintenance
- Failure of consumable items (such as batteries)
- Accidental damage
- Cosmetic damage
- Failure to follow manufacturer's guidelines
- Loss of use of the goods

This guarantee does not affect your statutory rights. This guarantee is only valid in the UK,

For any enquiries relating to the guarantee please refer to your retailer.

Should you experience any issues with this Titan product, please do not return it to Store. Please contact the Titan 2 Stroke Helpline on: 0333 2000 339 or email cs@h-gr8.co.uk

25CC PETROL MULTI TOOL TTK587GDO

CONTENTS

1. SAFETY INSTRUCTIONS	6
GENERAL SAFETY INSTRUCTIONS	6
Preparation	6
Operation	7
Maintenance and storage	8
Brush cutter and grass trimmer safety instructions	8
Pole mounted hedge trimmer safety instructions	8
Pruner safety instructions	9
Causes and operator prevention of kickback	10
Fuel handling	10
Vibration and noise reduction	10
Emergency	11
Residual risks	11
Vibration	12
2. TECHNICAL INFORMATION	14
SYMBOLS	14
YOUR PRODUCT	17
A. Main Unit	17
B. Brush Cutter/Grass Trimmer	18
C. Hedge Trimmer Attachment	18
D. Pruner Attachment	19
E. Tools	20
3. ASSEMBLY INSTRUCTIONS	21
INTENDED USE	21
Unpack	21
AUXILIARY HANDLE ASSEMBLY	21
Adjusting The Handle	22
Attachments	22
Pole Extension Attachment Assembly	22

BRUSH CUTTER/GRASS TRIMMER GUARD ASSEMBLY	23
Brush Cutter Guard Assembly	23
Grass Trimmer Guard Assembly	23
BRUSH CUTTER BLADE ASSEMBLY	24
GRASS TRIMMER ASSEMBLY	25
PRUNER ATTACHMENT	25
Pole extension/pruner shaft	25
Replace chain and guide bar.....	25
Saw Chain Tensioning	28
CHAIN LUBRICATION	29
Filling Chain Oil	29
Checking Chain Oil	29
HARNESS	30
QUICK START	32
4. OPERATING INSTRUCTIONS	34
FUEL AND ENGINE OIL	34
STARTING INSTRUCTIONS	35
Cold Start	35
Warm Start	36
OPERATION	37
STOPPING	37
GENERAL BEHAVIOUR	37
Brush Cutter	38
Grass Trimmer	38
Hedge Trimmer	40
Pruner	43
Kickback	43
Pruning	44
Cutting Thin Branches	45
Cutting Thick Branches	46
After Use	46

5. MAINTENANCE	47
GENERAL CLEANING	47
Blade (Brush Cutter)	47
Trimmer Head	47
Blade (Hedge Trimmer)	48
Guide Bar and Saw Chain Maintenance	49
Guide Bar.....	49
SAW CHAIN SHARPING	50
AIR FILTER	51
FUEL TANK.....	52
FUEL FILTER	52
SPARK PLUG	52
BEVEL GEAR	53
CARBURETTOR	53
REPAIR	53
STORAGE	53
TRANSPORTATION	53
ENVIRONMENTAL PROTECTION	54
6. TROUBLESHOOTING	55
7. PRODUCT SPECIFICATIONS	56
Brush Cutter	56
Grass Trimmer	57
Hedge Trimmer.....	57
Pruner	58

1. SAFETY INSTRUCTIONS



Warning! Read these instructions carefully before operating this tool. Make sure that you are familiar with the controls and know how to properly operate the machine. By following these instructions, you can reduce the risk of fire, electric shock and personal injury.

GENERAL SAFETY INSTRUCTIONS

1. This product is not intended for use by persons (including children) with reduced physical, sensory or mental capabilities, or lack of experience and knowledge, unless they have been given supervision or instruction concerning use of the product by a person responsible for their safety.
2. Children should be supervised to ensure that they do not play with the product.

IMPORTANT

**Read carefully before use
Keep for future reference**

3. Read the instructions carefully. Become familiar with the instruction manual before attempting to operate the product.
4. Never allow children or people unfamiliar with these instructions to use the product. Local regulations can restrict the age of the operator.
5. Never operate the product while people, especially children, or pets are nearby.
6. Keep in mind that the operator or user is responsible for accidents or hazards occurring to other people or their property.

Preparation

1. This product can cause serious injuries. Read the instructions carefully for the correct handling, preparation, maintenance, starting and stopping of the product. Become familiar with all controls and the proper use of the product.
2. Never allow children to use this product.
3. Avoid operating while people, especially children, are nearby.
4. Dress properly! Do not wear loose clothing or jewellery which can be caught in moving parts. Use of sturdy gloves, non-skid footwear and safety glasses is recommended.
5. Take extra care when handling fuel. They are flammable and the vapours are explosive. The following points should be observed:
 - Only use approved containers to store fuel.
 - Never remove the fuel tank cap or add fuel with the power source running. Allow engine and exhaust components to cool down before refuelling.
 - Do not smoke when operating fuelling, or starting this machine.
 - Never refuel indoors or in confined spaces.
 - Never store the product or fuel container inside where there is an open flame, such as near a boiler.
 - If fuel is spilled, do not attempt to start the product, but move it away from the area of spillage before starting.
 - Always replace and securely tighten the fuel tank cap after refuelling.
 - Drain fuel outdoors only.
6. If the cutting mechanism strikes any foreign object or the product starts making any unusual noise or vibration, shut off the power source and allow the product to stop. Disconnect the spark plug wire from the spark plug and take the following steps:

- Inspect for damage.
- Check and tighten any loose parts
- Have any damaged parts replaced or repaired with parts having equivalent specifications.

Operation

1. This product should not be used for any other purpose than described. Note that national regulations can restrict the use of this product.
2. Working with this product is demanding; therefore, ensure you are physically and mentally fit to complete the job safely. Do not use the product when you are tired, ill or under the influence of alcohol or other drugs.
3. Pay attention to your posture; always use the provided harness and keep your back straight. Do not overwork yourself. Take regular breaks to ensure concentrated work and full control over the product.
4. Keep a firm footing and balance during operation. Always be sure of a safe and secure operating position, whilst using the product. Never use the product standing on steps or a ladder.
5. Always wear substantial footwear and long trousers while operating. Do not operate the product when barefoot or wearing open sandals. Wear protective glasses or goggles.
6. Thoroughly inspect the area where the product is to be used and remove all objects which can be thrown by the product.
7. Before using the product and after any impact, check for signs of wear or damage and repair as necessary.
8. Never operate the product with damaged guards or without the guards in place.
9. Keep hands and feet away from the cutting means at all times, and especially when switching on the motor.
10. Never allow children or people unfamiliar with the instructions to use the product.
11. Stop using the product while people, especially children, or pets are nearby.
12. Only use the product in daylight or good artificial light.
13. Stop the engine before
 - Cleaning or when clearing a blockage,
 - Checking, carrying out maintenance or working on the product,
 - Adjusting the working position of the cutting device,
 - Leaving the product unattended.
14. Ensure that the product is correctly located in a designated working position before starting the engine.
15. While operating the product, always ensure that the operating position is safe and secure.
16. Do not operate the product with a damaged or excessively worn cutting blades chain or edges.
17. Keep the engine and silencer free of debris, leaves and excessive lubricant to reduce fire hazards.
18. Always ensure that all handles and guards are fitted when using the product. Never attempt to use an incomplete product or one fitted with an unauthorised modification.
19. Always use two hands to operate a product fitted with two handles.
20. Always be aware of your surroundings and stay alert for possible hazards of which you may not be aware due to the noise of the product.
21. Always ensure that ventilation openings are kept clear of debris.

Maintenance and storage

1. Improper maintenance and removal of safety devices leads to hazards causing injuries and damage to property.
2. When the product is stopped for servicing, inspection or storage, shut off the power source, disconnect the spark plug connector from the spark plug and make sure all moving parts have come to a stop. Allow the product to cool before making any inspections, adjustments, etc.
3. Always store the product and fuel so that there is no risk of leakages or fumes coming into contact with sparks or naked flames from electrical equipment, electric motors, relays/switches, boilers etc. Always allow the product to cool down before storing.
4. When not in use store the product out of the reach of children.
5. Use only manufacturers recommended replacement parts and accessories.
6. When transporting or storing the product, always fit the transportation guards.
7. Correctly secure your product when transporting in a vehicle to prevent turnover, fuel spillage and damage to the product.
8. For longer periods of storage or transportation the fuel and oil tanks must be emptied. Dispose of waste fuel and oil at a local petrol station, local authority centre or where facilities exist.

Brush cutter and grass trimmer safety instructions

1. Wear head protection, where there is a risk of falling objects.
2. Wear eye protection (goggles or face shield).
3. Wear ear protection.
4. Wear foot protection and gloves (on brush cutters).
5. Keep a distance between the product and bystanders of at least 15 m.
6. Beware of thrown object.
7. Take care against injury from any device fitted for trimming the filament line length. After extending new cutting device line always return the product to its normal operating position before switching on.

Pole mounted hedge trimmer safety instructions

1. Keep all parts of the body away from the cutter blade. Do not remove cut material or hold material to be cut when blades are moving. Make sure the product is switched off when clearing jammed material. A moment of inattention while operating the product may result in serious personal injury.
2. Carry the product by the handle with the cutter blade stopped. When transporting or storing the product always fit the cutting device cover. Proper handling of the product will reduce possible personal injury from the cutter blades.
3. Hold the product by insulated gripping surfaces only, because the cutter blade may contact hidden wiring. Cutter blades contacting a "live" wire may make exposed metal parts of the product "live" and could give the operator an electric shock.
4. Check the hedge for foreign objects before operation, e.g. wire fences.
5. Hold the product properly, e.g. with both hands if two handles are provided. Loss of control can cause personal injury.
6. Beware of overhead power lines. Do not use the product in any position that causes any part to come within 10m of overhead electrical lines.

Pruner safety instructions

1. Do not overwork yourself. Take regular breaks to ensure concentrated work and full control over the product. A moment of inattention while operating the product may result in serious personal injury.
2. Keep all parts of the body away from the saw chain. Do not remove cut material or hold material to be cut when saw chain is moving. Make sure the product is switched off when clearing jammed material. A moment of inattention while operating the product may result in serious personal injury.
3. Hold the product by insulated gripping surfaces only, because the saw chain may contact hidden wiring. Saw chains contacting a "live" wire may make exposed metal parts of the product "live" and could give the operator an electric shock.
4. Keep all parts of the body away from the saw chain when the product is operating. Before you start the product, make sure the saw chain is not contacting anything. A moment of inattention while operating this product may cause entanglement of your clothing or body with the saw chain.
5. Always hold the product with your right hand on the rear handle and your left hand on the front handle. Holding the product with a reversed hand configuration increases the risk of personal injury and should never be done.
6. Wear safety glasses and hearing protection. Further protective equipment for head, hands, legs and feet is recommended. Adequate protective clothing will reduce personal injury by flying debris or accidental contact with the saw chain.
7. Do not operate the product in a tree. Operation of a product while up in a tree may result in personal injury.
8. Always keep proper footing and operate the product only when standing on fixed, secure and level surface. Slippery or unstable surfaces such as ladders may cause a loss of balance or control of the product.
9. When cutting a limb that is under tension be alert for spring back. When the tension in the wood fibres is released the spring loaded limb may strike the operator and/or throw the product out of control.
10. Use extreme caution when cutting brush and saplings. The slender material may catch the saw chain and be whipped toward you or pull you off balance.
11. Carry the product by the front handle with the product switched off and away from your body. When transporting or storing the product always fit the guide bar cover. Proper handling of the product will reduce the likelihood of accidental contact with the moving saw chain.
12. Follow instructions for lubricating, chain tensioning and changing accessories. Improperly tensioned or lubricated chain may either break or increase the chance for kickback.
13. Keep handles dry, clean, and free from oil and grease. Greasy, oily handles are slippery causing loss of control.
14. Cut wood only. Do not use the product for purposes not intended. For example: do not use the product for cutting plastic, masonry or non-wood building materials. Use of the product for operations different than intended could result in a hazardous situation.
15. Pay attention to national and local regulations. National and local regulations may restrict the use of this product.
16. Remove branches in sections.
17. Beware of dangerous operating positions as well as of the risk of being struck by falling branches or by those that rebound after hitting the ground.
18. Beware of overhead power lines. Do not use the product in any position that causes any part to come within 10m of overhead electrical lines.
19. Never cut in areas where the cutting attachment is out of sight.

Causes and operator prevention of kickback

1. Kickback may occur when the nose or tip of the guide bar touches an object, or when the wood closes in and pinches the saw chain in the cut.
2. Tip contact in some cases may cause a sudden reverse reaction, kicking the guide bar up and back towards the operator.
3. Pinching the saw chain along the top of the guide bar may push the guide bar rapidly back towards the operator.
4. Either of these reactions may cause you to lose control of the saw which could result in serious personal injury. Do not rely exclusively upon the safety devices built into your saw. As a chain saw user, you should take several steps to keep your cutting jobs free from accident or injury.
5. Kickback is the result of tool misuse and/or incorrect operating procedures or conditions and can be avoided by taking proper precautions as given below:
 - a). **Maintain a firm grip, with thumbs and fingers encircling the chain saw handles, with both hands on the saw and position your body and arm to allow you to resist kickback forces.** Kickback forces can be controlled by the operator, if proper precautions are taken. Do not let go of the chain saw.
 - b). **Do not overreach and do not cut above shoulder height.** This helps prevent unintended tip contact and enables better control of the chain saw in unexpected situations.
 - c). **Only use replacement bars and chains specified by the manufacturer.** Incorrect replacement bars and chains may cause chain breakage and/or kickback.
 - d). **Follow the manufacturer's sharpening and maintenance instructions for the saw chain.** Decreasing the depth gauge height can lead to increased kickback.

Fuel handling

1. Always disconnect the spark plug connector and let the product cool down, before refuelling it. Petrol is easily flammable. Never smoke when you are refuelling the product. Do not refuel the product, if there is an open fire in the vicinity!
2. Always use suitable aids such as funnels and filler necks. Do not spill any fuel on the product or its exhaust system. There is a risk of ignition. Remove spilled fuel carefully from all parts of the product. Any residue which may be present must have completely volatilised, before the product is put into operation!
3. Never use the product in environments where there is a risk of explosion. Exhaust gases and fuel fumes are noxious. Fuel fumes can ignite.
4. Never breathe in any fuel fumes, when you are refuelling the product. Never fill the tank in enclosed spaces, such as basements or sheds. There is a risk of poisoning and explosion!
5. Avoid skin contact with petrol.
6. Do not eat or drink, while you are refuelling the product. If you have swallowed petrol or oil, or if petrol or oil has got into your eyes, then seek the advice of a doctor immediately.
7. Close the tank lid immediately after filling the tank. Make sure that it is properly closed.
8. Never use the product without an air filter.

Vibration and noise reduction

1. To reduce the impact of noise and vibration emission, limit the time of operation, use low-vibration and low-noise operating modes as well as wear personal protective equipment.
2. Take the following points into account to minimize the vibration and noise exposure risks:
 - Only use the product as intended by its design and these instructions.
 - Ensure that the product is in good condition and well maintained.
 - Use correct application tools for the product and ensure they in good condition.
 - Keep tight grip on the handles/grip surface.
 - Maintain this product in accordance with these instructions and keep it well lubricated (where appropriate).
 - Plan your work schedule to spread any high vibration tool use across a number of days.

Emergency

Familiarise yourself with the use of this product by means of this instruction manual. Memorise the safety directions and follow them to the letter. This will help to prevent risks and hazards.

1. **Always be alert when using this product, so that you can recognise and handle risks early.** Fast intervention can prevent serious injury and damage to property.
2. **Stop the engine and unplug the spark plug connector if there are malfunctions.** Have the product checked by a qualified professional and repaired, if necessary, before you operate it again.
3. **In case of fire stop the engine and unplug the spark plug connector.** Take fire-extinguishing measures immediately if the product switch is no longer accessible.



WARNING! Never use water to extinguish a product on fire. Burning fuel must be extinguished with special extinguishing agents. We recommend that you keep a suitable fire extinguisher within reach in your work area!

Residual risks



WARNING! Even if you are operating this product in accordance with all the safety requirements, potential risks of injury and damage remain. The following dangers can arise in connection with the structure and design of this product:

1. Health defects resulting from vibration emission if the product is being used over long periods of time or not adequately managed and properly maintained.
2. Injuries and damage to property due to broken accessories or the sudden impact of hidden objects during use.
3. Danger of injury and property damage caused by flying objects.
4. Burns, if touching hot surfaces.



WARNING! This product produces an electromagnetic field during operation! This field may under some circumstances interfere with active or passive medical implants! To reduce the risk of serious or fatal injury, we recommend persons with medical implants to consult their doctor and the medical implant manufacturer before operating this product!

Vibration

The European Physical Agents (Vibration) Directive has been brought in to help reduce hand arm vibration syndrome injuries to power tool users. The directive requires power tool manufacturers and suppliers to provide indicative vibration test results to enable users to make informed decisions as to the period of time a power tool can be used safely on a daily basis and the choice of tool.

Further Advice can be found at www.hse.gov.uk

Vibration total values (triax vector sum) determined according to EN ISO 11680-1, EN ISO 11806, EN ISO 10517:	
Max. vibration level for operation	Vibration emission value $a_h = 16.695\text{m/s}^2$
	Uncertainty $K = 1.5\text{m/s}^2$

The declared vibration emission value should be used as a minimum level and should be used with the current guidance on vibration.

Calculating the actual period of the actual period off use can be difficult and the HSE website has further information.

The declared vibration emission been measured in accordance with a standard listed test stated above and may be used to compare one tool with another. The declared vibration emission value may also be used in a preliminary assessment of exposure.



WARNING! The vibration emission value during actual use of the power tool can differ from the declared value depending on the ways in which the tool is used dependant on the following examples and other variations on how the tool is used:

How the tool is used and the materials being ground or cut.

The tool being in good condition and well maintained.

The use the correct accessory for the tool and ensuring it is sharp and in good condition.

The tightness of the grip on the handles.

And the tool is being used as intended by its design and these instructions.

This tool may cause hand-arm vibration syndrome if its use is not adequately managed.



WARNING! Identify safety measures to protect the operator that are based on an estimation of exposure in the actual conditions of use (taking account of all parts of the operating cycle such as the times when the tool is switched off and when it is running idle in addition to the trigger time). Note The use of other tools will reduce the users' total working period on this tool.

Helping to minimise your vibration exposure risk.

Maintain this tool in accordance with these instructions and keep well lubricated (where appropriate).

Avoid using tools in temperatures of 10°C or less.

Plan your work schedule to spread any high vibration tool use across a number of days.
Health Surveillance.

Health Surveillance.

All employees should be part of an employer's health surveillance scheme to help identify any vibration related diseases at an early stage, prevent disease progression and help employees stay in work.

Double insulation:

The tool is double insulated. This means that all the external metal parts are electrically insulated from the mains power supply. This is done by placing insulation barriers between the electrical and mechanical components making it unnecessary for the tool to be earthed.

Important note:

Be sure the supply is the same as the voltage given on the rating plate. The tool is fitted with a two-core cable and plug. Remove the mains plug from socket before carrying out any adjustment or servicing.

2. TECHNICAL INFORMATION

SYMBOLS



Warning



Read the instruction manual



Compliance with relevant safety standards



Wear ear protection
Wear safety helmet
Wear eye protection!



Wear respiratory protection



Wear face protection!



Gloves with saw protection



Wear safety footwear



Wear protective clothing



To avoid potential electric shock, do not use the unit in humid or wet conditions



Beware of blade thrust: Continued movement of saw blade after cutting through log.



Objects thrown by the product could hit the user or other bystanders. Always ensure that other people and pets remain at a safe distance from the product when it is in operation. In general, children must not come near the area where the product is. Minimum distance 15 m.



Always beware of the danger from overhead electric-power line, keep a safe distance at least 15M from the power line.



Risk of fire / flammable materials



Hot surface, do not touch. The high temperatures on the product's surfaces and structural parts could cause burns if touched. The product can also remain hot for a long period of time after operation!



This product produces noxious exhaust fumes. If the product is not used properly, these fumes can lead to poisoning, a loss of consciousness or death!



Warning! Switch the product off and disconnect the spark plug connector before assembly, cleaning, adjustments, maintenance, storage and transportation.



Objects thrown by the product could hit the user or other bystanders. Always ensure that other people and pets remain at a safe distance from the product when it is in operation. In general, children must not come near the area where the product is. Minimum distance 15m.



40:1



Only use petrol/oil mixture with a ratio of 40:1. Do not use any other mixture ratio. Always switch the product off and let it cool down, before refuelling it.



Naked flames in the work area, around the product and in the vicinity of flammable materials are prohibited!



Do not smoke in the work area, around the product and in the vicinity of flammable materials!



Maximum rotational frequency of the shaft for the cutting attachment in min^{-1}



Inspect the area where the product is to be used and remove all objects which can be thrown by the product. If objects are hidden while operating stop the engine and remove the object.



Contact of the guide bar tip with any object should be avoided.



Correct direction of cutting-teeth.



Location of starter handle: pull upwards



Refill chain oil



Do not touch the cutting device until it stops completely.



Guaranteed sound power level



Risk of long hair being drawn into air inlet.



Risk of loose clothing being drawn into air intake.

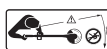

Keep other people out of working area during operation. A distance of at least 15 m must be observed.

YOUR PRODUCT

A. Main Unit

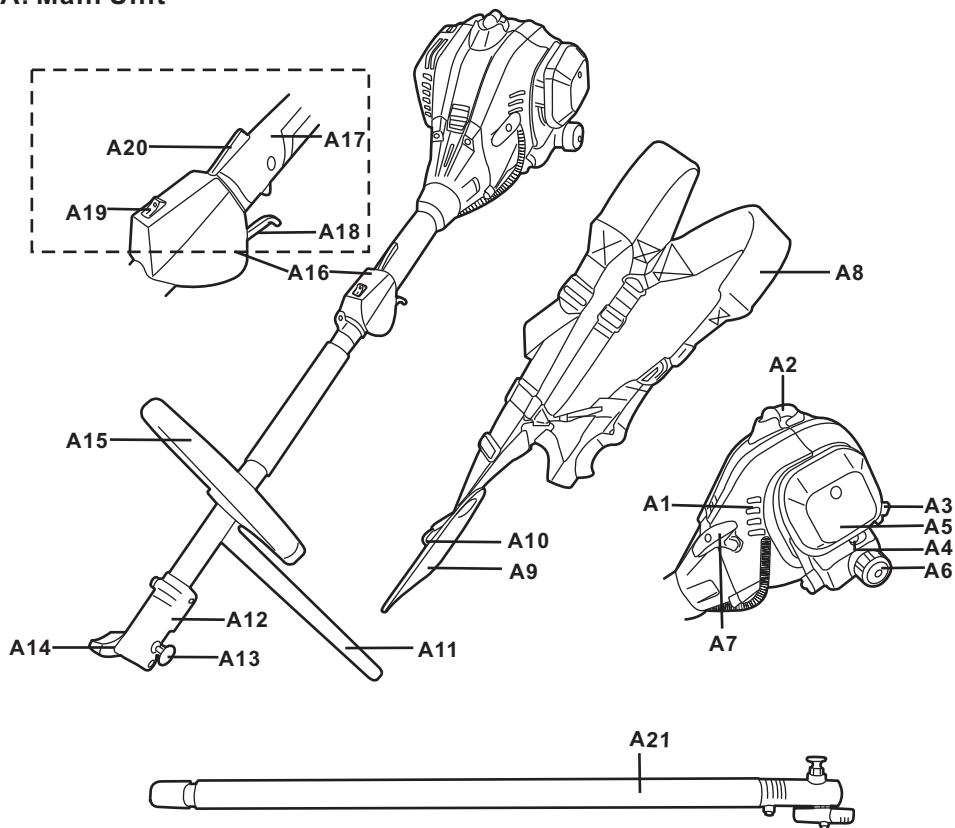

A1. Air vents	A12. Clamp
A2. Spark plug connector	A13. Locking pin
A3. Choke lever	A14. Locking knob
A4. Primer	A15. Auxiliary handle
A5. Air filter case	A16. Control unit
A6. Fuel tank cap	A17. Handle grip
A7. Recoil starter handle	A18. Throttle trigger
A8. Harness	A19. Ignition switch ON/OFF
A9. Hip protection	A20. Throttle interlock
A10. Securing clip	A21. Pole extension
A11. Step guard	

B. Brush cutter/Grass trimmer

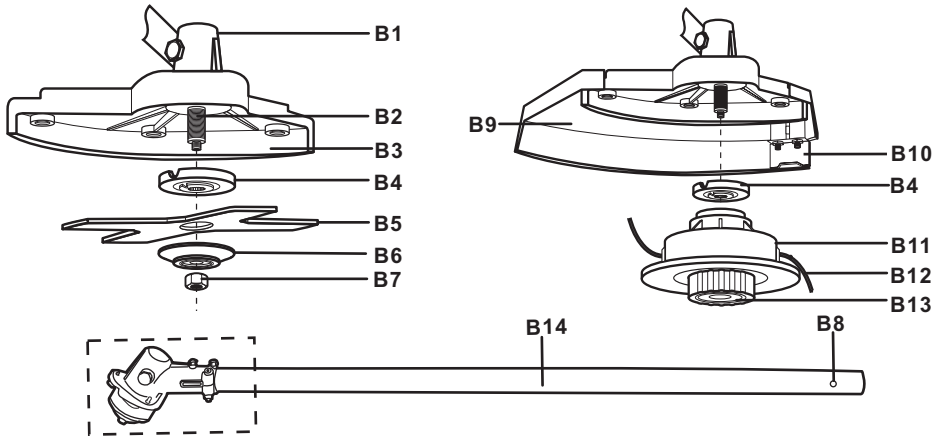

B1. Gear box	B8. The hole
B2. Spindle	B9. Trimming guard
B3. Cutting guard	B10. Line cutter
B4. Backing flange	B11. Trimming head
B5. Cutting blade	B12. Trimming line
B6. Locking flange	B13. Bumper
B7. Safety nut	B14. Brush cutter/grass trimmer shaft

C. Hedge trimmer attachment

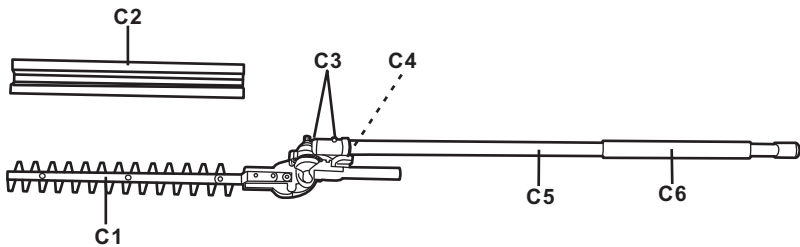

C1. Hedging blade	C5. Hedge trimmer shaft
C2. Blade protection sheath	C6. Gripping surface
C3. Bolts	
C4. Unlock levers	

D. Pruner attachment

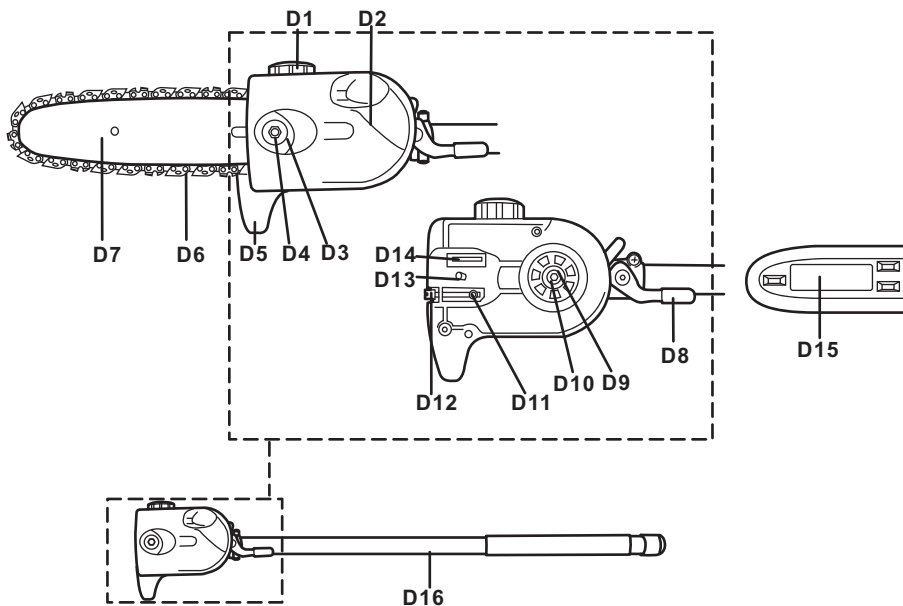

D1. Chain oil tank cap	D9. Clutch
D2. Cover	D10. Drive sprocket
D3. Locking nut	D11. Tension pin
D4. Spring washer	D12. Tension screw
D5. Pivot	D13. Bolt
D6. Saw chain	D14. Oiling port
D7. Guide bar	D15. Guide bar cover
D8. Locking lever	D16. Pruner shaft

E. Tools

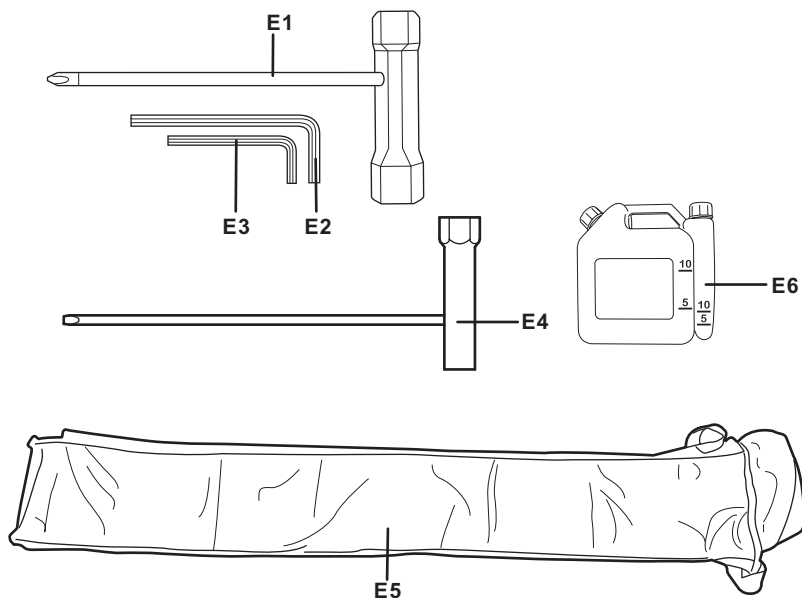

E1. Multi tool I: Cross-head screw driver / socket wrench	E4. Multi tool II: Socket wrench / flat end screw driver
E2. Hex key 5 mm	E5. Package bag
E3. Hex key 4 mm	E6. Fuel/oil mixing bottle

Accessories	
Harness	1PC
Multi Tool	1PC
Hex Key (4mm)	1PC
Hex Key (5mm)	1PC
Package Bag	1PC
Fuel/oil mixing bottle	1PC

3. ASSEMBLING INSTRUCTIONS



WARNING! Read all instructions carefully. Do not connect the spark plug before it is completely assembled. Always use gloves during assembly.

INTENDED USE

1. This 4 in 1 petrol multi-tool TTK587GDO is designated with an engine displacement of 25cm³. Depending on the attached accessory this product is intended to be used as:
 - a). **Brush Cutter:** With the cutter blade attached the product is intended to cut heavier weeds, brush and similar vegetation.
 - b). **Grass trimmer:** With the line spool attached the product is intended to cut smaller types of weed, lawn grass or similar soft vegetation. It must not be used to work on unusually thick, dry or wet grass, e.g. pasture grass, or to shred leaves.
 - c). **Pole hedge trimmer:** With the hedge trimmer blade attached the product is intended for trimming wide and high hedges, bushes and shrubs.
 - d). **Pruner:** With the saw chain/guide bar assembly attached the product is intended for cutting limbs with a thickness of max. 180 mm. The product may only be used with the guide bar/saw chain combination stated in these instructions. It is not permitted to use other types or sizes.
2. The product must not be used for cutting other materials, such as plastic, stone, metal or wood that contains foreign objects and must not be used outside of domestic premises.
3. Observe the technical data for the maximum cutting capacity according to the application (see "**Technical Information**"). Do not cut plants exceeding the stated maximum capacity.
4. This product is intended for private domestic use only, not for any commercial trade use. It must not be used for any purposes other than those described.

Unpack

1. Unpack all parts and lay them on a flat, stable surface.
2. Remove all packing materials and shipping devices if applicable.
3. Make sure the delivery contents are complete and free of any damage. If you find that parts are missing or show damage do not use the product but contact your dealer. Using an incomplete or damaged product represents a hazard to people and property.
4. Ensure that you have all the accessories and tools needed for assembly and operation. This also includes proper personal protective equipment.
5. Disconnect the spark plug connector from the spark plug.



WARNING! Be careful with small parts that are removed during assembly or when making adjustments. Make sure you do not lose them.

AUXILIARY HANDLE ASSEMBLY

1. Loosen the outer pre-assembled screws on the auxiliary handle (A15) with 4mm hex key (E3).

NOTE: There are holes on the bottom side of the upper shaft above the clamp to adjust the position of the handle.

2. Align the step guard (A11) with the screw to the desired hole on the shaft.
3. Place the handle onto the shaft from the top and secure it with hex bolts. Tighten them with the hex key (E3). (See Fig. 1a)

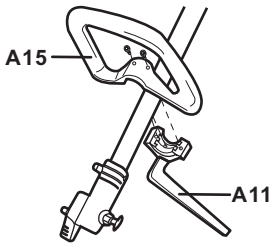

Fig. 1a

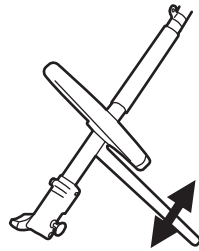

Fig. 1b

Adjusting The Handle

Adjust the position and angle of the auxiliary handle (A15) on the upper shaft.

1. Loosen the bolts on the auxiliary handle (A15) and adjust the position. (See Fig. 1b)
2. Afterward tighten the bolts.

Attachments



WARNING! Read all the instructions carefully! Do not start the product until it is completely assembled! Always wear gloves during assembly!

Assemble the relevant attachment to suit the intended application.

NOTE: This product can be used with different cutting heads for different applications. Follow the assembly steps for respective application.

Pole extension Attachment Assembly

NOTE: Use the pole extension only together with the hedge trimmer (C) or pruner attachment (D). It can not be used with the brush cutter/grass trimmer attachment (B).

1. Remove the protection cap from the pole extension (A21).
2. Align the extension (A21) with the clamp (A12) so that the hole in the extension is orientated to the locking pin. (See Fig. 2a)

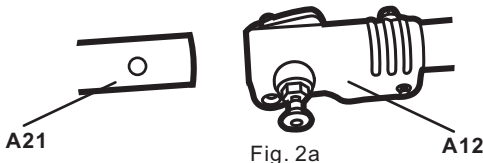

Fig. 2a

A12

3. Pull out the locking pin (A13) and insert the extension (A21) into the clamp (A12). Rotate the extension (A21) slightly to let the locking pin engage in the hole. Release the locking pin. Always ensure the locking pin engages in the hole. (See Fig.2b)

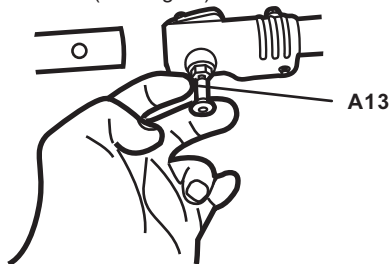

Fig. 2b

4. Secure the connection by tightening the locking knob (A14) clockwise. (See Fig. 2c)

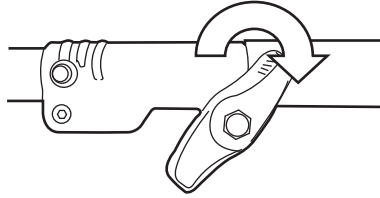

Fig. 2c

NOTE: The cutting attachments are attached in the same way as the pole extension.

BRUSH CUTTER/GRASS TRIMMER GUARD ASSEMBLY

The safety guard for the brush cutter and grass trimmer comes in two separate parts, to be adapted dependent on purpose.

Brush Cutter Guard Assembly

The brushcutter guard and trimming guard have been pre-assembled.

1. Remove the three pre-assembled screws with flat end screw driver (E4) on the gear head.

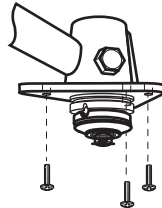

Fig. 3a

2. Rotate the backing flange (B4) until one of the notches is aligned with the hole in the gear head.
3. Insert the spindle lock rod (E3) into the hole to lock the spindle (B2).
4. Loosen the safety nut (B7) clockwise with socket wrench Multi tool (E1) and take it off together with the locking flange (B6) and backing flange (B4) (See Fig.3b)
5. Place the cutting guard (B3) onto the support and fix it with the screws by using the flat end multi tool (E4). Pay attention to the alignment of the brushcutter guard. (See Fig. 3c)

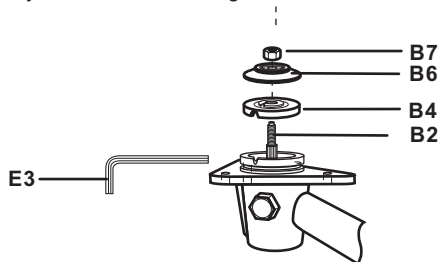

Fig. 3b

If you intend to use the product as brush cutter, proceed to **"Brush cutter assembly"**.

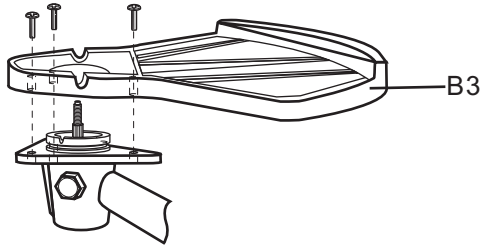

Fig. 3c

Grass Trimmer Guard Assembly

If you intend to use the product as grass trimmer additionally attach the trimming guard (B9)(provided pre-assembled). Fix the trimming guard (B9) and with three fixed bolts (E2) (See Fig.3d). Then proceed as per "Grass trimmer assembly" below.

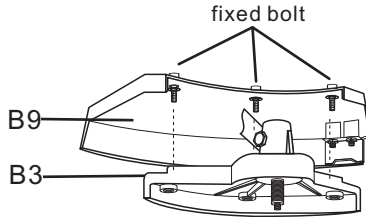

Fig. 3d

BRUSH CUTTER BLADE ASSEMBLY

1. Make sure that the brushcutter guard (B3) has been attached properly and the trimming guard have been removed from the outer edge.
2. Put the backing flange (B4) onto the spindle (B2).
3. Fit the blade (B5) to the spindle (B2). The rotational direction indicated on the guard and that of the blade must agree. Ensure that the blade sits securely on the extruded ring on the backing flange.
4. Rotate the backing flange (B4) until its hole is aligned with the notch in the gear head.
5. Insert the 4mm hex key (E3) into the hole to lock the spindle (B2).
6. Put the locking flange (B6) onto the blade (B5).
7. Secure the blade (B5) with the safety nut (B7) anticlockwise using socket wrench multi tool (E1).(See Fig. 4)
8. Remove the 4mm hex key (E3).

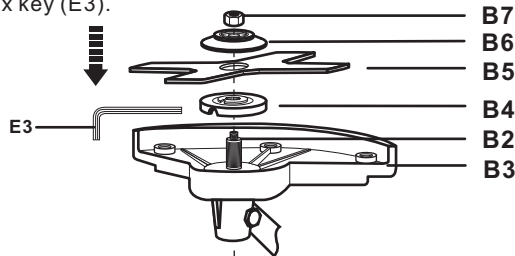

Fig. 4

GRASS TRIMMER ASSEMBLY

1. Make sure that the cutting guard (B3) and trimming guard (B9) have been attached properly.
2. Put the backing flange (B4) onto the spindle (B2).
3. Rotate the backing flange (B4) until its hole is aligned with the notch in the gear head.
4. Insert the spindle lock rod (E3) into the hole to lock the spindle.
5. Screw the trimmer head (B11) on the spindle (B2) anticlockwise, and tighten it securely. (See Fig. 5)
6. Remove the 4mm hex key (E3).

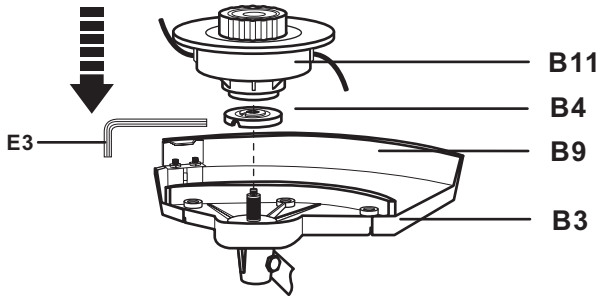

Fig. 5



WARNING! Do not attach the locking flange (B6) when using the trimmer head!

Pruner Attachment

- Pole extension/Pruner shaft

1. Fit the pruner shaft (D16) directly to the upper shaft if no pole extension is required.
2. Fit the pole extension to the upper shaft if required, and then fit the pruner shaft to the pole extension.

Replace chain and guide bar

1. Use only the guide bar (D7) and saw chain (D6) according to the technical data of the product.



WARNING! Always use a saw chain designed as “low-kickback” or a saw chain which meets the low-kickback requirements! A standard saw chain (a chain which does not have the kickback reducing guard links) should only be used by an experienced professional operator! Nevertheless, a low-kickback saw chain does not completely eliminated kickback! A low-kickback or “safety” chain should never be regarded as complete protection against injury!

2. Place the product on a suitable flat surface with the cover (D2) facing upwards.
3. Loosen locking nut (D3) with the socket wrench (E4) anticlockwise and remove it together with the spring washer (D4) and cover (D2). (See Fig. 6a, 6b)

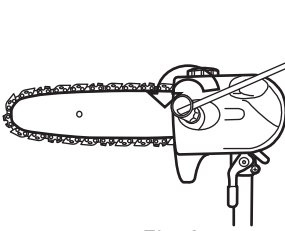

Fig. 6a

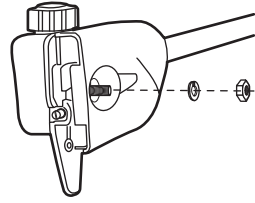

Fig. 6b

4. Turn the tension screw (D12) clockwise with the slotted screwdriver (E4), and make sure the tension pin(D11) is adjusted to its closer position. (See Fig. 6c)

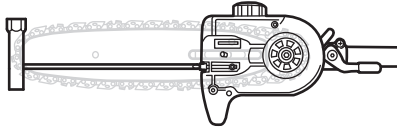

Fig. 6c

5. Take off the guide bar and chain. (See Fig.6d)

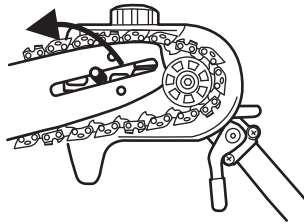

Fig. 6d

6. Ensure that the tension pin (D11) is adjusted to its far right position before assembly the checked or the new chain and guide bar. If not, turn the tension screw (D12) anticlockwise with the slotted screwdriver (E4). (See Fig. 6e)

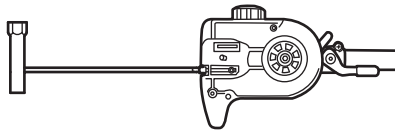

Fig. 6e

7. Spread the saw chain (D6) around the guide bar (D7). Slide the chain into the groove around the guide bar. Pay attention to the cutting direction.
8. Align the saw chain around the drive sprocket (D10) and place one corner of the guide bar into a gap of the sprocket. (See Fig. 6f)



WARNING! The direction of the saw chain 'cutters' must be as indicated by the arrow on the pruner head!

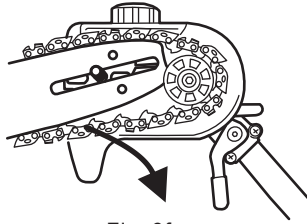

Fig. 6f

9. Make sure the tension pin (D11) is inserted into the lower hole on the guide bar. (See Fig. 6g)

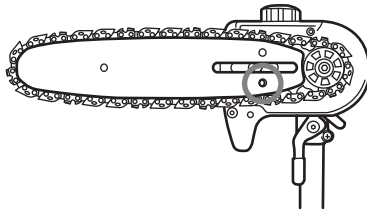

Fig. 6g

10. Put it together with the spring washer (D4) and cover (D2), and tighten locking nut (D3) with the socket wrench (E4) clockwise. (See Fig. 6h, 6i)



NOTE: The saw chain (D6) has not yet been tensioned. Tension the chain as described under "**Saw chain tensioning**". After operating the product for approx. 30min, adjust the chain

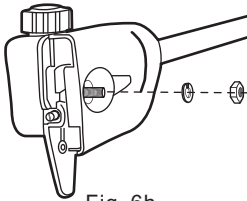

Fig. 6h

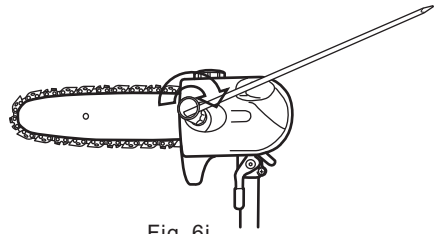

Fig. 6i

Saw Chain Tensioning

Always check the saw chain tension before use, after first cuts and regularly during use, approx. every five cuts. After initial operation, new chains can lengthen considerably. This is normal during the break-in period and the interval between future adjustments will lengthen quickly.



WARNING! Always switch the product off and disconnect the spark plug connector before adjusting the saw chain tension!

The cutting edges of the saw chain are sharp. Always wear protective gloves when handling the chain!

Always maintain proper chain tension! A loose chain increases the risk of kickback! A loose chain may jump out of the guide bar groove! This may injure the operator and damage the chain! A loose chain will cause rapid wear to the chain, guide bar and sprocket!



Tensioning the chain too tightly will overload the engine and cause damage, and insufficient tension can cause chain derailing, whereas a correctly tightened chain provides the best cutting characteristics and prolonged working life! The chain life mainly depends upon sufficient lubrication and correct tensioning!

1. Lift the tip of the guide bar (D7) and keep it there as you adjust the tension.
2. Turn the tension screw (D12) clockwise with multi tool(E4) until the chain "tie straps" are just touching the bottom edge of the guide bar (D7). (See Fig. 7a)

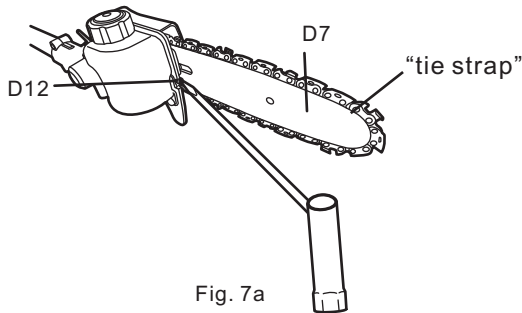

3. Check the chain tension using one hand to lift the saw chain (D6) against the weight of the product. The correct chain tension is achieved when the saw chain can be lifted by approx. 2-4mm from the guide bar (D7) in the centre. (See Fig. 7b, 7c)

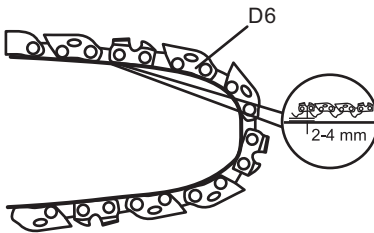

Fig. 7b

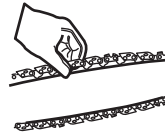

Fig. 7c

4. Turn the locking nut (D3) to tighten the cover (D2) completely.

CHAIN LUBRICATION

Filling Chain Oil



WARNING! The product is not filled with chain oil. It is essential to fill the product with chain oil before using it! Never operate the product without chain oil as this will result in extensive damage to the product!!



Operating the saw chain dry or with too little chain oil will decrease cutting efficiency, shorten the product life span and cause rapid wear to the saw chain and guide bar from overheating! Insufficient chain oil is evident by smoke or bar discoloration! Adequate lubrication of the saw chain during cutting operations is essential to minimise friction with the guide bar!

1. Set the product on any suitable surface with the chain oil tank cap (D1) facing upwards. (See Fig. 8a)

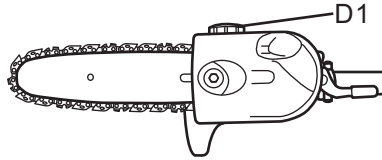

Fig. 8a

2. Unscrew and remove the tank cap (D1), then add the lubricant into the tank. We recommend using environmentally-friendly chain oil specifically intended to be used with this product.
3. Use a proper funnel with a filter to prevent debris entering the tank and to avoid spilling and overflowing the tank. Do not overfill and leave approximately 5 mm of space to the lower edge to allow the lubricant to expand. (See Fig. 8b)

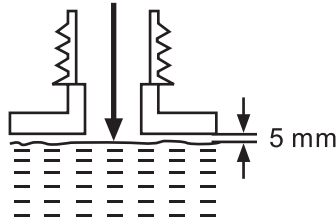

Fig. 8b

4. Wipe up spilled fuel with a soft cloth and refit the chain oil tank cap (D1).

NOTE: Always dispose of lubricant, used oil and objects contaminated with them in accordance with local regulations.

Checking Chain Oil

Check the chain lubrication before each use.

NOTE: This product is equipped with an automatic oiling system! The oiling system automatically delivers the proper amount of oil to the bar and chain! Checking the lubrication requires starting the engine. Before checking the product must be fully assembled and all instructions must have been read.

1. Make sure the guide bar (D7) and the saw chain (D6) are in place when you check the oil delivery.
2. Start the engine; keep it running at medium power and check if the chain oil is delivered as shown in the figure. (See Fig. 8c)

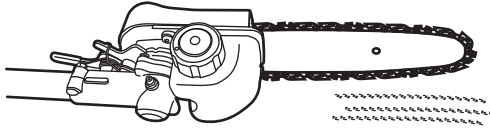

Fig. 8c

HARNESS

The harness (A8) helps the operator carry this product.



WARNING! Always attach the product to the harness. Do not carry it just by hand!

1. To remove the harness from the loop, open the securing clip (A10).
2. Place the harness so that it runs over the left and right shoulder, crossing the chest and back. The securing clip must be located at the right hip. (See Fig. 9a, 9b)



Fig. 9a

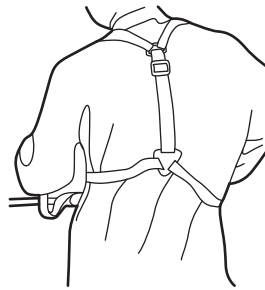

Fig. 9b

3. Adjust the length of the harness (A8) so that the hook is approximately 15 cm below your waist; locate the product to the harness by using the securing clip ensuring that the angle of the cutting head is parallel to the surface being cut. (See Fig. 9c)



WARNING! Always attach the product to the harness. Do not carry it only with your hands.



Fig. 9c

4. In case of emergency, pull the rope of the quick release mechanism. The metal locking bar will be released from the securing clip automatically because of the weight of the machine, and the machine will drop away from you. (See Fig. 9d)

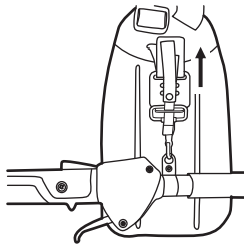
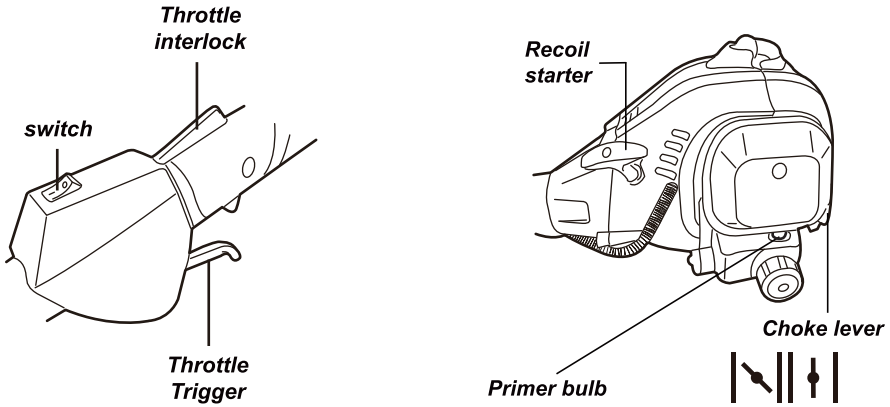

Fig. 9d

Quick start



SET UP



Assemble



Adjust



Add fuel / oil mixture

COLD START

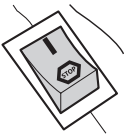

Set ignition switch to "I"



Close choke

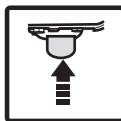

Press primer 6 times until fuel is visible



Pull recoil starter handle until engine starts

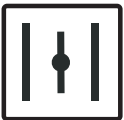

Open choke



Run at idle speed for 30 seconds



Operate

WARM START



Set ignition switch to "I"

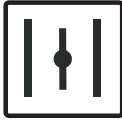

Open choke



Pull recoil starter handle until engine starts



Run idle



Operate

STOPPONG

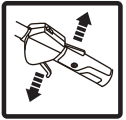

Release throttle control and interlock



Run idle



Set ignition switch to "stop"



Empty fuel tank



Maintain



Store



WARNING! This quick start provides only a short overview of how to start and stop the product! For safe use it is essential to read the entire instruction manual before first use!

4. OPERATING INSTRUCTIONS

FUEL AND ENGINE OIL

This product is equipped with a 2-stroke engine, the fuel and oil tank are combined and it is essential to fill a fuel-oil mixture before operating this product. Observe the technical specifications for suitable fuel and engine oil.



WARNING! This product is not supplied with fuel-oil mixture in the engine! Before operating this product it is essential to fill it with fuel!



WARNING! Fuel and oil are highly inflammable! Fumes will explode if lit! Ensure that there are no naked flames around the product! Do not smoke while filling fuel and oil!

1. Place the product on a stable, level surface. We recommend laying a non-flammable sheet under the product.
2. Mix a regular-grade unleaded petrol and a quality engine oil for air cooled 2 stroke engines in a suitable container.
3. Use an anti-oxidant added quality oil expressly labelled for air-cooled 2 stroke engine use (JASO FC GRADE OIL or ISO EGC GRADE). Do not use BIA or TWC (2 stroke water-cooling type) mixed oil.
4. The recommended mixing ratio for petrol : oil is 40:1. (See Fig. 10)



Fig. 10

5. Unscrew and remove the fuel tank cap (A6).
6. Fill correctly mixed fuel/oil into the tank using a fuel funnel (NO SUPPLIED) fitted with a filter to avoid debris entering the tank. Do not overfill. Leave a minimum 5 mm of space between the top of the fuel and the inside edge of the tank to allow for expansion. (See Fig. 11a, 11b)

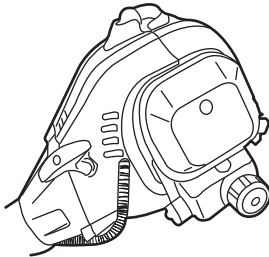

Fig. 11a

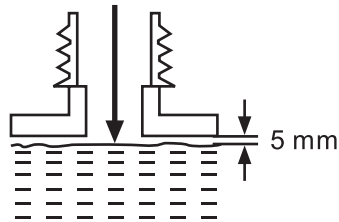

Fig. 11b

7. Avoid spilling and overfilling the tank.
8. Wipe up spilled fuel with a soft cloth and refit the fuel tank cap (A6).
9. Always dispose of fuel, used oil and soiled objects according to local regulations (see section "**Environmental Protection**").

NOTE: Fuel and oil deteriorate over time. It may be difficult to start the engine if you use fuel which has been kept for more than 30 days. Towards the end of the season, it is advisable to put only as much fuel in the tank as you need for each mowing of the lawn, since it should be completely used up before storing the product. Empty remaining fuel from the tank when storing the product for over 30 days.

STARTING INSTRUCTIONS

Cold Start

1. Place the product on a flat, stable surface. Ensure that the attachment in use does not touch the ground or any objects.
2. Set the ignition switch (A19) to its on position "I". (See Fig. 12a)

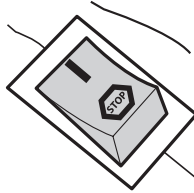

Fig. 12a

3. Move the choke lever (A3) to the position |↗|. (See Fig. 12b)
4. Depress the primer (A4) 6 times until fuel is visible. (See Fig. 12c)

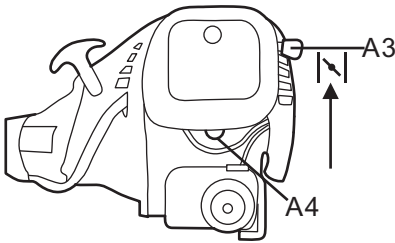

Fig. 12b

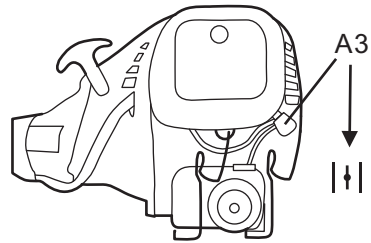

Fig. 12c

5. Pull the recoil starter handle (A7) firmly; repeat until the engine starts. (See Fig. 12d)
6. Move the choke lever (A3) to position |↕|, allow the product to run at idle speed for 30 seconds to let it warm up.
7. Once the engine is running correctly, carefully lift the product and securely hold it by its handles.

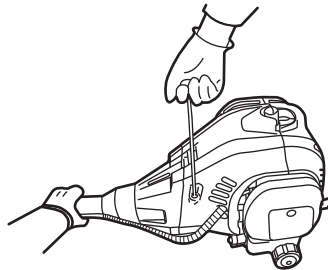

Fig. 12d



WARNING! Make sure that the cutting blade is not touching the ground or other objects when starting the product!

NOTE: During idle running the cutting blade should not move. Contact a qualified technician if you find that the cutting blade is moving.

Warm start

1. Place the product on a flat, stable surface. Ensure that the attachment in use does not touch the ground or any objects.
2. Set the ignition switch (A19) to its on position "I". (See Fig. 13a)

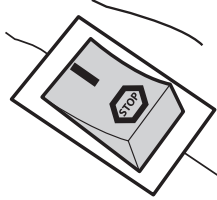

Fig. 13a

3. Move the choke lever (A3) to the position |↑|, do not press the primer. (See Fig. 13b)

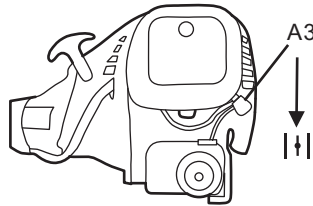

Fig. 13b

4. Pull the recoil starter handle (A7) firmly; repeat until the engine starts. (See Fig. 13c)

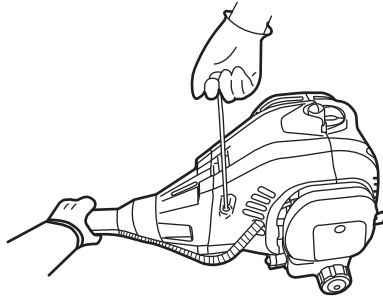

Fig. 13c



WARNING! Make sure that the cutting blade is not touching the ground or other objects when starting the product! Allow the recoil starter rope to return slowly and controlled after each pull!

OPERATION

1. Press the throttle interlock (A20), hold it in position and then press the throttle trigger (A18) to engage the attachment (Fig. 14).
2. Release the throttle trigger (A18), this tool will be set at idle speed status.

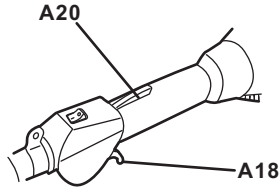

Fig. 14

STOPPING

1. Release the throttle trigger (A18) and let the product run at idle speed for 10-15 seconds.
2. Set the ignition switch (A19) to its off position "STOP". (See Fig. 15)

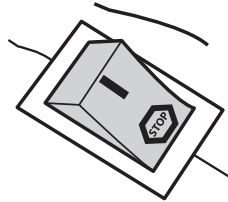

Fig. 15



WARNING! The attachment will continue to move for some time even after the engine has been switched off! Wait until the attachment has come to a complete stop before placing the product on the ground!

GENERAL BEHAVIOUR

1. Check the product as well as accessories for damage before each use. Do not use the product if it is damaged or shows wear.
2. Double check that accessories, safety guards and blades are properly fixed.
3. Always hold the product by its handles. Keep the handles dry to ensure safe support.
4. Ensure that the air vents are always unobstructed and clean. Clean them if necessary with a soft brush. Blocked air vents may lead to overheating and damage the product.
5. Switch the product off immediately if you are disturbed while working with it and when other people enter the working area. Always let the product come to complete stop before putting it down.
6. Do not overwork yourself. Take regular breaks to ensure you can concentrate on the work and have full control over the product.

Brush Cutter



WARNING! To avoid hazards never cut heavier weeds, brush and similar vegetation with a thickness of over 20mm. Avoid contact with stones, wire, glass etc. that may cause injury to the user! Inspect the blade regularly for damage, cracks or breaks! Always replace a damaged blade!



WARNING! When working with the cutter blade there is always a risk of kickback if the cutting head comes into contact with a hard object! Kickback will cause the sudden stalling of the cutting head, which in turn results in the cutting head being forced in the opposite direction to the rotation of the cutter blade! Ensure that you retain a firm grip with both hands at any sign of such kickback, pay attention and retain a firm stance to avoid injuries!

1. Use the cutter blade (B5) to cut heavier weeds, brush and similar vegetation with a thickness of up to 20mm.
2. Hold the product firmly so that it sits with a gap between the product and your right side.
3. Stand upright, do not lean forward and pay attention to posture. Keep both feet apart to help retain your balance.
4. Never hold the cutting head higher than your hip; the higher you hold the cutting head will increase the risk of objects being thrown. (See Fig. 16)

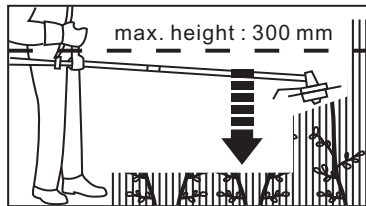

Fig. 16

5. Carefully plunge the blade from above when cutting long undergrowth.
6. Move the cutting head towards the base of young trees or thicker vegetation.

Grass Trimmer

1. Use the trimmer head (B11) to cut smaller types of weed, lawn grass or similar soft vegetation.
2. Remove the protection cap from the line cutter (B10).
3. Hold the product firmly so that it sits with a gap between the product and your right side.
4. Stand upright, do not lean forward and pay attention to posture. Keep both feet apart to help retain your balance.
5. Hold the trimmer head just above the ground at an angle of approximately 30°. (See Fig. 17a)

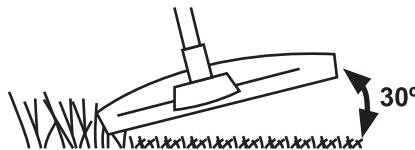

Fig. 17a

6. Move the product with slow and regular arc from left to right before moving it back to the starting position before trimming the next area. (See Fig. 17b)

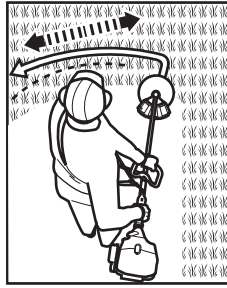

Fig. 17b

7. Ensure the cutting head remains clean and free from off-cuts that may cause it to jam. Check regularly. Stop the engine, switch the ignition switch (A19) to “STOP” and remove the spark plug connector (A2) before checking.
8. Trim longer grass in stages, do not cut long grass in one cut. For the best results, cut longer grass in steps. (See Fig. 17c, 17d)

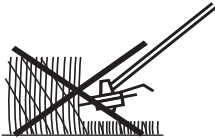

Fig. 17c

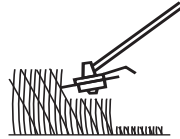

Fig. 17d

9. The trimmer head is equipped with a bumper (B13) helping to cut the trimming line (B12) while operating. Simply tap the bumper on a firm surface and the spool will release fresh trimming line. (See Fig. 17e)

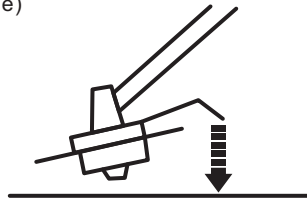

Fig. 17e

10. A line cutter (B10) is integrated with the trimming guard (B9) and this will cut the line to the necessary length. (See Fig. 17f)



WARNING! The cut line will be thrown out! Danger of injury especially for bystanders!

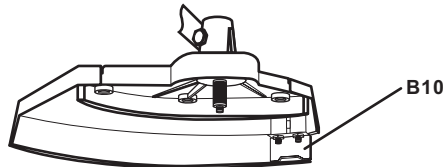

Fig. 17f

- 11. For best results, do not cut wet grass because it tends to stick to the cutting heads and guard, prevents proper discharge of grass trimmings, and could cause you to slip and fall.
- 12. Pay special attention when performing the work close to trees and bushes. The cutting heads could damage sensitive bark, and damage fence posts. (See Fig. 17g)

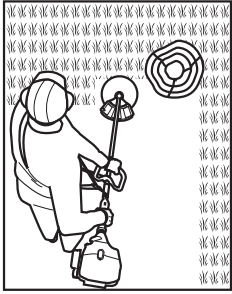

Fig. 17g

**Hedge Trimmer
Angle adjustment**

Adjust the attachment angle to suit working conditions.

- 1. Depress the unlock levers (C4) with one hand and hold them in position. (See Fig. 18a)

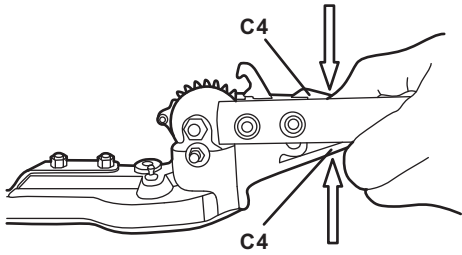

Fig. 18a

- 2. Move the hedge trimmer shaft (C5) with the other hand until the desired angle is adjusted. (See Fig. 18b)

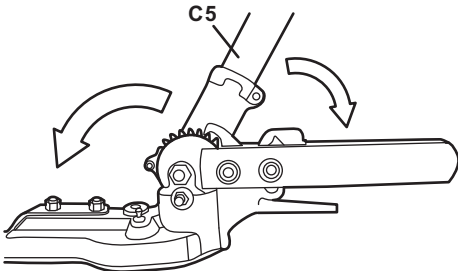

Fig. 18b

3. Release the unlock levers (C4) when the desired angle is adjusted. Ensure that the hook engages between two teeth of the tooth wheel. (See Fig. 18c)

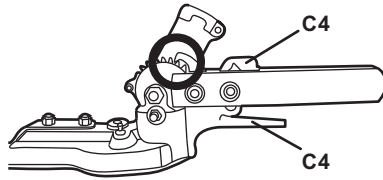

Fig.18c

Trimming

1. Prepare the product to required length attaching the pole extensions and/or the hedge trimmer shaft.
2. Cut and remove branches exceeding the cutting capacity of this product using a proper pruner before operation.
3. Always hold the product firmly with both hands on gripping surface and handle grip (A17). Never operate this product using only one hand.
4. Cut both sides from the bottom cutting upwards to the top. This will prevent any of the cuttings falling into the path of the area still to be cut. (See Fig. 19a)



Fig.19a

5. After cutting the sides proceed to the top.
6. When cutting wide hedges with the cutting area in sight move the cutting blade lightly through the cutting surface in a sweeping motion following the shape of the hedge or shrub. A slight tilt downwards of the cutting blade in the direction of motion is recommended for optimum cutting performance. (See Fig. 19b)



Fig. 19b

7. Move the product with slow motion forward when cutting higher hedge and the cutting area out of sight. (See Fig. 19c)



Fig. 19c

8. Do not to rush and do not attempt to cut too much with one stroke of the cutting blade.

NOTE: Try to keep the cutting blade angled at approximately 15° to the cutting surface.

9. Cut in a number of stages if the area being cut is particularly long to achieve a better result; smaller cuttings will allow for easy composting.

NOTE: When shaping it is advisable to achieve a trapezoidal shape (See Fig. 19d). A trapezoidal cut corresponds to the natural growth of plants and results in optimal hedge growth, as it will expose more light to the bottom of the hedge.

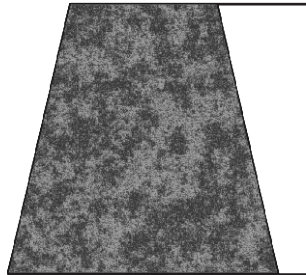

Fig. 19d

Pruner

Angle adjustment

Adjust the attachment angle to suit working conditions.

1. Press the locking lever (D8) downward and hold it in position. (See Fig. 20a)

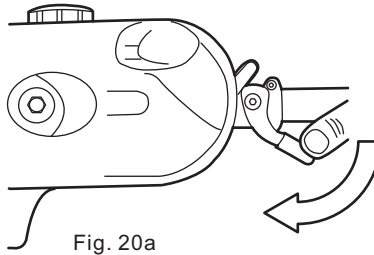

Fig. 20a

2. Adjust the pruner head to required position and then release the locking lever (D8). (See Fig. 20b)



WARNING! Ensure the locking lever returns to its initial position! To test if the unlock lever is properly engaged try to move the pruner head! It may not be possible to adjust the angle!

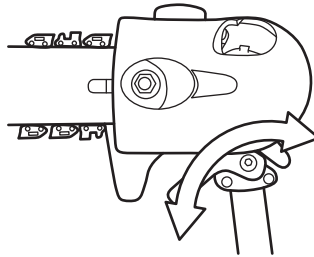

Fig. 20b

Kickback



WARNING! Beware of kickback! Kickback can lead to dangerous loss of control of the product and result in serious or fatal injury to the operator or anyone standing close by! Always be alert because rotational kickback and pinch kickback are major product operational dangers and the leading cause of most accidents!

1. Kickback is the sudden backward/upward motion of the product, occurring when the chain (at the tip of the chain bar) comes in contact with a log or wood, or when the chain becomes jammed.
2. When kickback occurs the product reacts unpredictably and can cause severe injuries to the operator or bystanders.
3. With a basic understanding of 'kickback', the element of surprise can be reduced or eliminated. Sudden surprise contributes to the majority of accidents.
4. You should read all the safety warnings and user instructions carefully before attempting to operate this product.

To avoid kickback:

- Never work with a loose, overstretched or worn out chain
- Ensure chain is sharpened correctly
- Never work with the tip of the guide bar
- Always hold the tool firmly with both hands
- Always use a low kickback chain
- Ensure correct chain tension

Pruning

1. Always hold the product firmly with both hands on gripping surface and handle grip (A17). Never operate this product using only one hand. (See Fig. 21a)

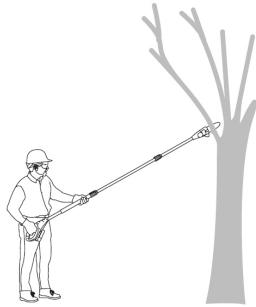

Fig. 21a

2. Maintain a firm grip with your thumbs and fingers encircling the handles. A firm grip will help you reduce 'kickback' and maintain control of the product.
3. Always hold the product at an angle of not more than 60° from the horizontal level. Otherwise safe operation is not possible. (See Fig. 21b)

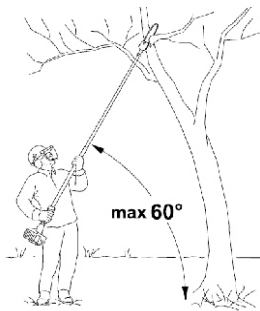

Fig. 21b

4. Never stand directly under the limb you are sawing. Objects may fall different than expected. Always position yourself out of the path of falling limbs. (See Fig. 21c)
5. Keep other persons away from cutting end of product and at a safe distance from the work area. Maintain a minimum distance of 10m to bystanders. (See Fig. 21d)



WARNING! Never climb into a tree to prune! Do not stand on ladders, platforms, logs, or in any position which may cause you to lose your balance or control of the product! When pruning trees, it is important not to make the flush cut next to main limb or trunk until you have cut off the limb further out to reduce the weight! This prevents stripping the bark from the main member!

6. Never stand on a ladder or other type of unstable support while using the product. Insecure stand invites hazards. (See Fig. 21e)



WARNING! This product has not been designed to provide protection from electric shock in the event of contact with overhead electric lines! Therefore do not use product near cable, electric power or telephone lines. Keep a minimum distance of 10 m to all electric lines. (See Fig. 21f)!

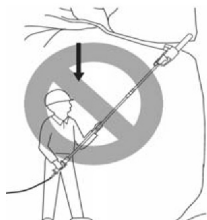

Fig. 21c



Fig. 21d



Fig. 21e

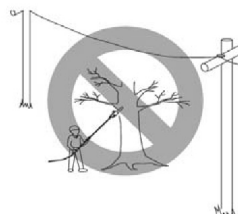

Fig. 21f

7. Use the product only with secure footing. Hold the product at the right-hand side of your body.
8. Do not operate the product with arms fully extended or attempt to cut areas which are difficult to reach.
9. Keep a firm, steady pressure on the product while working with it. Do not try to force the product through the wood, let the cutting device do the work, using the gripping teeth to apply minimal leverage pressure.
10. Beware when reaching the end of the cut. The weight of the product may change unexpectedly as it cuts free from the wood. Accidents can occur to the legs and feet. Always remove the product from a wood cut while it is running.

NOTE: The chain must be running at full speed before it comes into contact with the wood.

Cutting Thin Branches

Thin branches can be cut off with one single cut. To prevent the branch from slivering and buckling the branch should be cut off in several pieces. (See Fig. 22)



Fig. 22

Cutting Thick Branches

When cutting larger branches, three cuts are necessary as shown below:

NOTE: Remove the branches lying on the floor regularly to avoid stumbling hazards. Check the oil level regularly and fill up if necessary. Switch the power off and disconnect from power source when leaving the product.

1. First cut into the branch from below, outside of the location where you intend to cut off the branch. The cut should go one third to halfway through the branch. (See Fig. 23a)
2. Cut into the branch from the top, outside from where the branch is to be sawn. (See Fig. 23b)
3. Last, cut off the stump with one clean cut from top to bottom. You might want to seal the cut with a suitable compound. (See Fig. 23c)



Fig. 23a



Fig. 23b



Fig. 23c

4. You might want to seal the cut with a suitable compound.

NOTE: Remove the branches lying on the floor regularly to avoid stumbling hazards. Check the oil level regularly and fill up if necessary. Switch the power off and disconnect from power source when leaving the product.

After Use

1. Switch the product off, allow the engine to cool down and then remove the spark plug connector.
2. Check, clean and store the product as described below.

5. Maintenance



WARNING! Always switch the product off, let the product cool down and disconnect the spark plug connector before performing inspection, maintenance and cleaning work!



WARNING! Only perform repairs and maintenance work according to these instructions! All further works must be performed by a qualified specialist!



WARNING! Wear safety gloves when working on the attachment heads and close to it! Use appropriate tools to remove debris, e.g. a brush or wooden stick! Never use your bare hands!

Keep the product clean. Remove debris from it after each use and before storage. Regular and proper cleaning will help ensure safe use and prolong the life of the product. Inspect the product before each use for worn and damaged parts. Do not operate it if you find broken and worn parts.

GENERAL CLEANING

NOTE: Do not use chemical, alkaline, abrasive or other aggressive detergents or disinfectants to clean this product as they might be harmful to its surfaces.

1. Clean the product with a slightly damp cloth and mild soap. Use a brush for areas that are hard to reach.
2. In particular clean the air vents after every use with a cloth and brush.
3. Remove stubborn dirt with high pressure air (max. 3 bar).
4. Check for worn or damaged parts. Replace worn parts as necessary or contact an authorised service centre for repair before using the product again.

Blade (Brush Cutter)

1. Keep the cutting blade (B5) clean and free of debris. Remove clippings.
2. Keep the cutting blade (B5) sharp to retain a good cutting performance. Replace a worn or damaged cutting blade with a new one of the same type.

Trimmer Head

1. Keep the trimmer head (B11) clean and free of debris. Remove trimmings.
2. If the line is used up the spool must either be replaced by one of the same type or the trimming line (B12) must be refilled.
3. To refill the trimming line lay the product on a flat stable surface with its trimmer head facing upwards.
4. Rotate the backing flange until one of the notches is aligned with the hole in the gear head.
5. Insert the 4mm hex key (E3) into the hole to lock the spindle.
6. Remove the trimmer head (B11) by unscrewing clockwise. (See Fig. 24a)

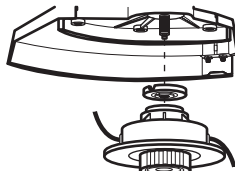

Fig. 24a

7. To replace the spool simply remove from the trimmer head (B11) and replace with a new one of the same type. (See Fig. 24b)

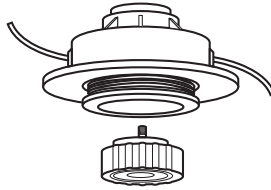

Fig. 24b

8. To replace the trimming line, press the release latch of the trimmer head housing to open the cover.
9. Cut a new 6 m long trimming line with a diameter of 2 mm. Form a loop at the middle of the line and insert this loop into the hook on the spool. (See Fig. 24c)

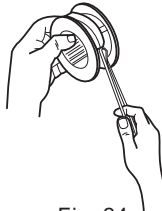

Fig. 24c

10. Wind the two parts of the trimming line in clockwise direction firmly around the spool each part in the guide on the spool. (See Fig. 24d)

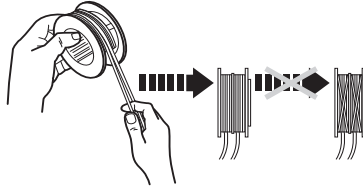

Fig. 24d

11. Insert each end of the threads in the respective holes. The threads should stick out 150 mm on each side.
12. Screw the bumper (B13) anti-clockwise until it is completely and safely locked.
13. Remove the 4mm hex key (E3).



WARNING! After changing the trimming line, run the product under no load for at least a minute to make sure that the line and the product are operating correctly!



WARNING! Never use steel thread! Always use cutting means in perfect condition, free of damage!

Blade (Hedge Trimmer)

1. Keep the hedging blade (C1) clean and free of debris. Remove trimmings.
2. Keep the hedging blade (C1) sharp to retain a good cutting performance. Replace a worn or damaged cutting blade with a new one of the same type.
3. Lubricate the hedging blade (C1) after each use to prolong the life span of cutting blade and product. Apply light machine oil along the edge of the cutting blade.

Guide Bar and Saw Chain Maintenance

Most guide bar problems can be prevented merely by keeping the product well maintained. Incorrect filling and non-standard cutter and depth gauge settings are the causes of most guide bar problems, primarily resulting in uneven bar wear. As the bar wears unevenly, the rails widen, which may cause the chain to clatter and make it difficult to complete straight cuts. If the guide bar is insufficiently lubricated and the product is operated with a saw chain which is too tight, this will contribute to rapid bar wear. To help minimise bar wear, maintenance of the guide bar as well as the saw chain is recommended.

1. Disassemble the guide bar and saw chain in reversed order from assembly.
2. Check the oiling port (D14) for clogging and clean if necessary to ensure proper lubrication of the guide bar and saw chain during operation. Use a soft wire small enough to insert into the oil discharge hole. (See Fig. 25a)

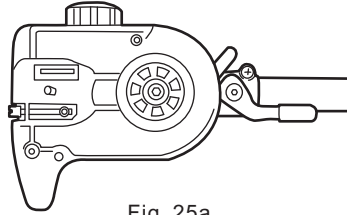

Fig. 25a

NOTE: The condition of the oil passages can be easily checked. If the passages are clear, the chain will automatically give off a spray of oil within seconds of the product starting. Your product is equipped with an automatic oiling system.

3. Check the drive sprocket (D10). If it is worn or damaged due to strain, have it replaced by an authorised service agent.
4. Clear residue from the rails on the guide bar (D7) using a screwdriver, putty knife, wire brush or other similar tool. This will keep the oil passages open to provide proper lubrication to the guide bar (D7) and saw chain (D6). (See Fig. 25b)



Fig. 25b

5. Check the guide bar 'rail' for wear: Hold a ruler (straight edge) against the side of the guide bar and 'cutter side plates'. If there is a gap between the ruler and guide bar the guide bar 'rail' is normal. If there is no gap (ruler flush against the side of the guide bar) the guide bar 'rail' is worn and needs to be replaced with a new one of the same type. (See Fig. 25c)

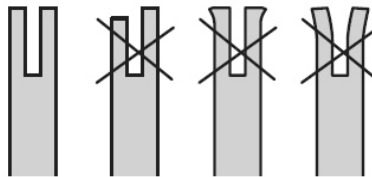

Fig. 25c

6. Turn the guide bar 180° to allow even wear, thereby extending the life span of the guide bar (D7).
7. Check the saw chain for possible wear and damages. Replace it with a new one if required. Experienced user can sharpen a dull saw chain (see section “**Saw chain sharpening**” below).
8. Refit the saw chain (D6) and the guide bar (D7) as described under “**Assembly**”.

SAW CHAIN SHARPENING



WARNING! Only sharpen the saw chain yourself if you are trained and have experience! Use proper tools to sharpen the saw chain!

NOTE: Never saw with a blunt chain. The saw chain is blunt if you have to push the product into the tree and the chips are very small.

1. Have the saw chain (D6) sharpened professionally at an authorised service centre or sharpen the chain yourself by using a suitable sharpening kit. Also observe the sharpening instructions supplied with the sharpening kit.
2. The height difference between the tooth and the ridge is the cutting depth. When sharpening the saw chain (D6) you have to consider the following points. (See Fig. 26a)
 - File angle
 - Cutting angle
 - File position
 - Diameter of round file
 - File depth

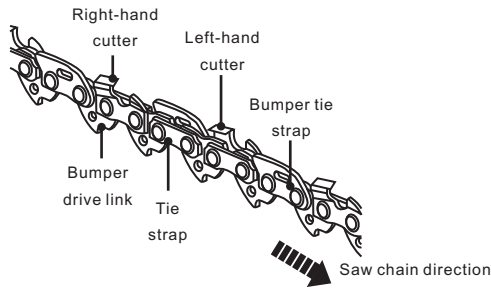

Fig. 26a

3. To sharpen the chain proceed as follows:
 - Use protective gloves.
 - Ensure the chain is correctly tensioned.
 - Engage the chain brake to lock the chain on the bar.
4. Use a suitable file, whose diameter is 1.1 times the cutting tooth depth. Make sure 20% of the file diameter is above the cutter's top plate.
5. A file guide is available from most reputable tool merchants and is the easiest way to hold the file at the correct position.
6. File at an angle perpendicular to the bar, and at an angle of 25° to the direction of travel. (See Fig. 26b)

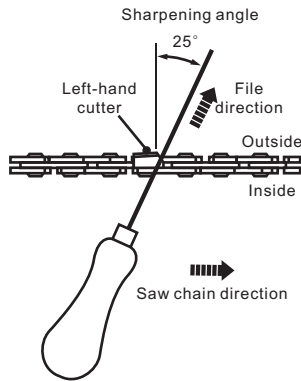

Fig. 26b

7. File each tooth from the inside towards outside only. File one side of the chain first than turn the saw around and repeat the process.
8. Sharpen each tooth equally by using the same number of strokes.
9. Keep all cutter lengths equal. Check the safety depth gauge height every 5 sharpenings. If the depth gauges are also trimmed it is essential that the original profile be restored.
10. Use a depth gauge measuring instrument to check the height of the depth gauge. Depth gauge measuring jigs are available from most reputable tool merchants. (See Fig. 26c)

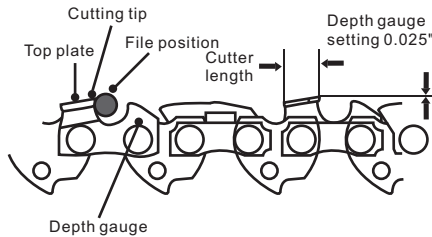

Fig. 26c

AIR FILTER

1. Inspect the air filter regularly. Replace it with a new one if necessary.
2. Open the air filter case (A5) with the cross-head screwdriver (E1), and remove the filter. (See Fig. 27)

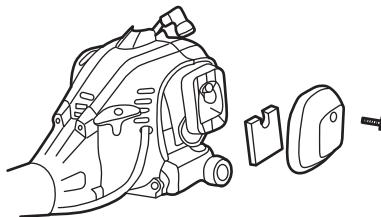

Fig. 27

3. Tap the filter on a stable surface to remove dust. Use compressed air (max. 3 bar) to remove stubborn dust.
4. Apply a small amount of air filter oil on the filter to increase the performance of the filter.
5. Wring out surplus oil and put the filter into the case.
6. Close the air filter cover.

FUEL TANK

1. Empty the fuel tank when storing the product over 30 days to prevent the fuel from deteriorating.
2. Unscrew and remove the fuel tank cap (A6) and use a proper fuel pump to empty the fuel into a suitable container.

FUEL FILTER

The fuel tank of this product is fitted with a filter located at the free end of the fuel pipe. Ask an authorised service centre or similar qualified person to check and where necessary replace it at regular intervals.

SPARK PLUG

NOTE! This engine uses a CHAMPION RCJ6Y spark plug with 0.6-0.7mm electrode gaps. Use a suitable replacement and replace once a year. You can it replace with "CHAMPION" or "NGK" as an alternative.

1. Inspect the spark plug at least every 25 hours or prior to long-term storage over 30 days if the use has not been this high. Clean or replace with a new spark plug if necessary.
2. Unplug the spark plug connector (A2). Loosen the spark plug with the socket wrench (E1) anticlockwise and carefully remove it. (See Fig. 28a)

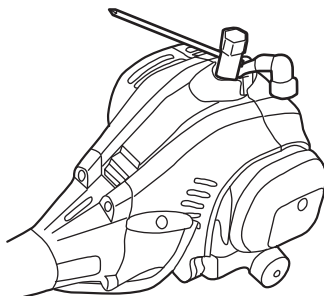

Fig. 28a

4. Check the spark plug for damage and wear. The colour of the electrode should be light-brown coloured.
5. Remove debris from the electrode with a soft wired brush; avoid heavy cleaning of the electrode.
6. Dry the spark plug with a soft cloth if it is wet from fuel.
7. Check the spark plug gap; it should be 0.6 - 0.7 mm. (See Fig. 28b)

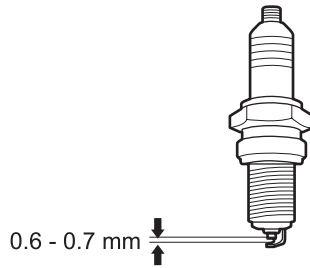

Fig. 28b

8. Replace with a new spark plug if either the electrode or the insulation is damaged
9. When replacing the spark plug, first screw it in hand tight and then lightly tighten it with the socket wrench(E1).



WARNING! Do not over-tighten the spark plug to avoid any damage!

BEVEL GEAR

The bevel gear is filled with grease. Ask an authorised service centre or similar qualified person to check the quantity regularly and fill up using proper grease if necessary.

CARBURETTOR

The carburettor is pre-set by the manufacturer. Should it be necessary to make any changes please contact an authorised service centre or a similarly qualified person. Do not attempt to make any adjustments by yourself.

REPAIR

This product does not contain any parts that can be repaired by the consumer. Contact a qualified specialist to have it checked and repaired.

STORAGE

1. Clean the product as described above.
2. Store the product and its accessories in a dry, frost-free, well-ventilated place.
3. Always store the product in a place that is inaccessible to children. The ideal storage temperature is between 10 and 30°C.
4. We recommend using the original package for storage or covering the product with a proper cloth or enclosure to protect it against dust.

TRANSPORTATION

1. Switch the product off and disconnect the spark plug connector before transporting it anywhere.
2. Attach transportation guards for cutting means of hedge trimmer, brush cutter and pruner.
3. Always carry the product by its handles.
4. Protect the product from any heavy impact or strong vibrations which may occur during transportation in vehicles.
5. Secure the product to prevent it from slipping or falling over.

ENVIRONMENTAL PROTECTION

1. Waste products should not be disposed of with household waste. Please recycle where facilities exist. Check with your Local Authority or local store for recycling advice.
2. Petrol, oil, old oil, a mixture of oil and petrol and objects soiled with oil e.g. cleaning cloths do not belong in the household rubbish. Dispose of oily items in accordance with local guidelines and hand them in at recycling centres.
3. The product comes in a package that protects it against damages during shipping. Keep the package until you are sure that all parts have been delivered and the product is function properly. Recycle the package afterwards.

6. Troubleshooting



WARNING! Suspected malfunctions are often due to causes that the user can fix themselves. Therefore check the product using this section. In most cases the problem can be solved quickly.



WARNING! Only perform the steps described within these instructions! All further inspection, maintenance and repair work must be performed by an authorised service centre or a similarly qualified specialist if you cannot solve the problem yourself!

Problem	Possible cause	Fault correction
Engine does not start	Not enough fuel in fuel tank	Add fuel
	Primer has been not pressed at cold start	Press the primer and restart
	Primer has been pressed at warm start	Dry spark plug
	Spark plug is wet	Dry spark plug
	Spark plug is damaged	Replace spark plug
	Spark plug connector lose	Attach properly
Engine stops	Not enough fuel in fuel tank	Add fuel
	Cutting device is blocked	Remove blockage
Unsatisfactory cutting performance	Cutting blade is dull/damaged	Have a specialist to sharpen or replace it
	Cutting material exceeds capacity	Only cut materials acc. to the capacity of the product
Excessive vibration/noise or exhaust	Cutting device is dull/damaged	Replace with a new one
	Bolts/nuts are loosen	Tighten bolts/nuts
	Petrol/oil is incorrect	Empty unused petrol/oil and refill with the correct petrol/oil

PRODUCT SPECIFICATIONS

Engine type	SL 33, air cooled 2-stroke
Engine displacement	25cc
Max. shaft break power	0.8 kW
Max. engine speed	10500 /min
Engine idle speed	3000 /min
Clutch engagement speed	4500 /min
Fuel tank volume	500 ml
Fuel type	#95, unleaded
Fuel consumption at maximum engine power	0.38 kg/h
Specific fuel consumption at maximum engine power	447 g/kWh
Engine oil type	2-cycle motor oil (2T FC)
Mixture ratio petrol : oil	40 : 1
Spark plug type	CHAMPION: RCJ6Y NGK: BPMR7A
Spark plug gap	0.6 – 0.7 mm
Net weight (without cutting attachment and with empty tanks)	approx. 6.4kg

BRUSH CUTTER

Blade Size	4 teeth, Ø230 x 1.8mm
Maximum rotational frequency of the spindle	8500 /min
Noise values	
Sound pressure level $L_{pA,ld}$	80.4 dB(A)
Sound pressure level $L_{pA,R}$	97.4 dB(A)
Sound pressure level $L_{pA,av}$	94.5 dB(A)
Uncertainty	3 dB(A)
Sound power level $L_{WA,m}$	109.7 dB(A)
Uncertainty	3 dB(A)
Guaranteed sound power level L_{WA}	112 dB(A)
Hand arm vibration	
Left handle a_h (at idling)	2.874 m/s ²
Left handle a_h (at racing)	4.472 m/s ²
Right handle a_h (at idling)	2.626 m/s ²
Right handle a_h (at racing)	3.717 m/s ²
Uncertainty	1.5 m/s ²

GRASS TRIMMER

Line spool diameter	Ø 2mm
Max. cutting width	430 mm
Maximum rotational frequency of the spindle	7300 /min
Noise values	
Sound pressure level $L_{pA,ld}$	76.1 dB(A)
Sound pressure level $L_{pA,R}$	96.5 dB(A)
Sound pressure level $L_{pA,av}$	93.5 dB(A)
Uncertainty	3 dB(A)
Sound power level $L_{WA,m}$	109.7 dB(A)
Uncertainty	3 dB(A)
Guaranteed sound power level L_{WA}	112 dB(A)
Hand arm vibration	
Left handle a_h (at idling)	3.192 m/s ²
Left handle a_h (at racing)	8.935 m/s ²
Right handle a_h (at idling)	2.475 m/s ²
Right handle a_h (at racing)	9.839 m/s ²
Uncertainty	1.5 m/s ²

HEDGE TRIMMER

Max. cutting length	365 mm
Max. cutting capacity	24 mm
No-load speed	2500/min
Adjustable cutting angle range	-90° — +60°
Noise values	
Sound pressure level $L_{pA,ld}$	77.7 dB(A)
Sound pressure level $L_{pA,R}$	96.5 dB(A)
Sound pressure level $L_{pA,av}$	93.5 dB(A)
Uncertainty	3 dB(A)
Sound power level $L_{WA,ld}$	87.0 dB(A)
Sound power level $L_{WA,R}$	109.4 dB(A)
Sound power level $L_{WA,av}$	106.4 dB(A)
Uncertainty	3 dB(A)
Guaranteed sound power level L_{WA}	112 dB(A)
Hand arm vibration	
Front handle a_h (at idling)	6.477 m/s ²
Rear handle a_h (at racing)	17.373 m/s ²
Front handle a_h (at idling)	4.960 m/s ²
Rear handle a_h (at racing)	16.695 m/s ²
Uncertainty	1.5 m/s ²

PRUNER

Chain oil tank	150 ml
Saw chain speed	21 m/s
Max. cutting length	180 mm
Guide bar length	203 mm
Guide bar type	552912
Saw chain type	91PJ033X
Chain pitch	9.525 mm (3/8")
Chain gauge (thickness of drive links)	1.27 mm (0.050")
Drive sprocket (teeth and pitch)	7 teeth x 9.525 mm(3/8")
Noise values	
Sound pressure level $L_{pA,ld}$	77.5 dB(A)
Sound pressure level $L_{pA,R}$	97.3 dB(A)
Sound pressure level $L_{pA,av}$	94.3 dB(A)
Uncertainty	3 dB(A)
Sound power level $L_{WA,ld}$	87.9 dB(A)
Sound power level $L_{WA,R}$	109.1 dB(A)
Sound power level $L_{WA,av}$	106.1 dB(A)
Uncertainty	3 dB(A)
Guaranteed sound power level L_{WA}	112 dB(A)
Hand arm vibration	
Front handle a_h (at idling)	6.303 m/s ²
Rear handle a_h (at racing)	13.254 m/s ²
Front handle a_h (at idling)	6.954 m/s ²
Rear handle a_h (at racing)	9.901 m/s ²
Uncertainty	1.5 m/s ²

The declared vibration value has been measured in accordance with a standard test method and may be used for comparing one tool with another.

The declared vibration value may also be used in a preliminary assessment of exposure.



WARNING! The vibration emission value during actual use of the tool can differ from the declared value depending on the ways in which the tool is used. Identify safety measures to protect the operator that are based on an estimation of exposure in the actual conditions of use (taking account of all parts of the operating cycle such as the times when the tool is switched off and when it is running idle in addition to the trigger time).

The sound intensity level for the operator may exceed 85dB(A) and ear protection measures are necessary.

The conformity assessment followed was according to Annex III of the directive for equipment listed in schedule 1 / article 13 the chosen conformity assessment route Internal control of production (schedule 10 / Annex V) - Guaranteed Sound Power Level 112 dB (A).

TITAN

Declaration of Conformity

We, Importer
Kingfisher International Products B.V.
Rapenburgerstraat 175E
1011 VM Amsterdam
The Netherlands

Declare that the product:
25CC Petrol Multi Tool
Model: TTK587GDO

Complies with the following directives:

2006/42/EC - Machinery Directive

- **EN ISO 11806-1:2011**
- **EN ISO 11680-1:2011**
- **EN ISO 10517:2019**
- **EN ISO 14982: 2009**

2000/14/EC amended by 2005/88/EC - Noise Emission in the Environment
by Equipment for
Use Outdoors Directive
The RoHS Directive **2011/65/EU** and its amendments
(EU) 2015/863 and **(EU) 2017/2102**

EC-Type Examination Certificate no.: M6A 072390 0028 Rev.00

Notified body: TÜV SÜD Product Services GmbH

Notified body identification number: 0123

EC-Type Examination Report no.: 704031407105-02

The Regulation of Non-Road Mobile Machinery Emissions
(EU) 2016/1628, and its supplemented regulations
• **Engine model number: SL33**

Authorised signatory and technical file holder

Date: **03/09/2019**

Signature: 

Name / title: Eric Capotummino / Group Quality Director
Kingfisher International Products B.V.
Rapenburgerstraat 175E
1011 VM Amsterdam
The Netherlands



25CC PETROL MULTI TOOL TTK587GDO