

TITAN



SAFETY AND OPERATING MANUAL

Should you experience any issues with this Titan product, please do not return it to Store.
Please contact the Titan 2 Stroke Helpline on: 0333 2000 339

Original Instructions
V100721 / BX220IM

25CC PETROL MULTI TOOL TTL488GDO

TITAN

Congratulations on your purchase of a **TITAN** power tool from Kingfisher International Products Limited. We want you to continue getting the best performance from it so this handbook includes information on safety, handling and care. Please retain this handbook in case you need to refer to any of the information in the future

Your **TITAN** power tool comes with a 1-year guarantee. Should it develop a fault within this period please do not return it to Store. Please contact the Titan 2 Stroke Helpline on: 0333 2000 339 in the first instance.

GUARANTEE

This **TITAN** product carries a guarantee of 1 year. If your product develops a fault within this period, you should, in the first instance contact: 0333 2000 339 (Mon – Fri : 09.00 – 17.00)

This guarantee specifically excludes losses caused due to:

- Fair wear and tear
- Misuse or abuse
- Lack of routine maintenance
- Failure of consumable items (such as batteries)
- Accidental damage
- Cosmetic damage
- Failure to follow manufacturer's guidelines
- Loss of use of the goods

This guarantee does not affect your statutory rights. This guarantee is only valid in the UK,

For any enquiries relating to the guarantee please refer to your retailer.

Should you experience any issues with this Titan product, please do not return it to Store. Please contact the Titan 2 Stroke Helpline on: 0333 2000 339 or email cs@b-gr8.co.uk

SAFETY INSTRUCTIONS



Warning! Read these instructions carefully before operating this tool. Make sure that you are familiar with the controls and know how to properly operate the machine. By following these instructions, you can reduce the risk of fire, electric shock and personal injury.

GENERAL SAFETY INSTRUCTIONS

1. This product is not intended for use by persons (including children) with reduced physical, sensory or mental capabilities, or lack of experience and knowledge, unless they have been given supervision or instruction concerning use of the product by a person responsible for their safety.
2. Children should be supervised to ensure that they do not play with the product.

IMPORTANT
Read carefully before use
Keep for future reference

Training

1. Read the instructions carefully. Become familiar with the instruction manual before attempting to operate the product.
2. Attend a training course if you are a first time user to get familiar with the operation of this product.
3. Never allow children or people unfamiliar with these instructions to use the product. Local regulations can restrict the age of the operator.
4. Never operate the product while people, especially children, or pets are nearby.
5. Keep in mind that the operator or user is responsible for accidents or hazards occurring to other people or their property.

Preparation

1. This product can cause serious injuries. Read the instructions carefully for the correct handling, preparation, maintenance, starting and stopping of the product. Become familiar with all controls and the proper use of the product.
2. Never allow children to use this product.
3. Avoid operating while people, especially children, are nearby.
4. Dress properly! Do not wear loose clothing or jewellery which can be caught in moving parts. Use of sturdy gloves, non-skid footwear and safety glasses is recommended.
5. Take extra care when handling fuel. They are flammable and the vapours are explosive. The following points should be observed:
 - Only use approved containers to store fuel.
 - Never remove the fuel tank cap or add fuel with the power source running. Allow engine and exhaust components to cool down before refuelling.
 - Do not smoke when operating fuelling, or starting this machine.
 - Never refuel indoors or in confined spaces.

25CC PETROL MULTI TOOL TTL488GDO

- Never store the product or fuel container inside where there is an open flame, such as near a water heater.
 - If fuel is spilled, do not attempt to start the product, but move it away from the area of spillage before starting.
 - Always replace and securely tighten the fuel tank cap after refuelling.
 - Drain fuel outdoors only.
6. If the cutting mechanism strikes any foreign object or the product starts making any unusual noise or vibration, shut off the power source and allow the product to stop. Disconnect the spark plug wire from the spark plug and take the following steps:
- Inspect for damage.
 - Check and tighten any loose parts
 - Have any damaged parts replaced or repaired with parts having equivalent specifications.

Operation

1. This product should not be used for any other purpose than described. Note that national regulations can restrict the use of this product.
2. Working with this product is demanding; therefore, ensure you are physically and mentally fit to complete the job safely. Do not use the product when you are tired, ill or under the influence of alcohol or other drugs.
3. Pay attention to your posture; always use the provided harness and keep your back straight. Do not overwork yourself. Take regular breaks to ensure concentrated work and full control over the product.
4. Keep a firm footing and balance during operation. Always be sure of a safe and secure operating position, whilst using the product. Never use the product standing on steps or a ladder.
5. Always wear substantial footwear and long trousers while operating. Do not operate the product when barefoot or wearing open sandals. Wear protective glasses or goggles.
6. Thoroughly inspect the area where the product is to be used and remove all objects which can be thrown by the product.
7. Before using the product and after any impact, check for signs of wear or damage and repair as necessary.
8. Never operate the product with damaged guards or without the guards in place.
9. Keep hands and feet away from the cutting means at all times, and especially when switching on the motor.
10. Never allow children or people unfamiliar with the instructions to use the product.
11. Stop using the product while people, especially children, or pets are nearby.
12. Only use the product in daylight or good artificial light.
13. Stop the engine before
 - Cleaning or when clearing a blockage,
 - Checking, carrying out maintenance or working on the product,
 - Adjusting the working position of the cutting device,
 - Leaving the product unattended.

14. Ensure that the product is correctly located in a designated working position before starting the engine.
15. While operating the product, always ensure that the operating position is safe and secure.
16. Do not operate the product with a damaged or excessively worn cutting chain or edges.
17. Keep the engine and silencer free of debris, leaves and excessive lubricant to reduce fire hazards.
18. Always ensure that all handles and guards are fitted when using the product. Never attempt to use an incomplete product or one fitted with an unauthorised modification.
19. Always use two hands to operate a product fitted with two handles.
20. Always be aware of your surroundings and stay alert for possible hazards of which you may not be aware due to the noise of the product.
21. Always ensure that ventilation openings are kept clear of debris.

Maintenance and storage

1. Improper maintenance and removal of safety devices leads to hazards causing injuries and damage to property.
2. When the product is stopped for servicing, inspection or storage, shut off the power source, disconnect the spark plug connector from the spark plug and make sure all moving parts have come to a stop. Allow the product to cool before making any inspections, adjustments, etc.
3. Always store the product and fuel so that there is no risk of leakages or fumes coming into contact with sparks or naked flames from electrical equipment, electric motors, relays/switches, boilers etc. Always allow the product to cool down before storing.
4. When not in use store the product out of the reach of children.
5. Use only manufacturers recommended replacement parts and accessories.
6. When transporting or storing the product, always fit the transportation guards.
7. Correctly secure your product when transporting in a vehicle to prevent turnover, fuel spillage and damage to the product.
8. For longer periods of storage or transportation the fuel and oil tanks must be emptied. Dispose of waste fuel and oil at a local petrol station, local authority centre or where facilities exist.

GRASS TRIMMER SAFETY INSTRUCTIONS

1. Wear head protection, where there is a risk of falling objects.
2. Wear eye protection (goggles or face shield).
3. Wear ear protection.
4. Wear foot protection and gloves (on brush cutters).

5. Keep a distance between the product and bystanders of at least 15 m.
6. Beware of thrown object.
7. Take care against injury from any device fitted for trimming the filament line length. After extending new cutting device line always return the product to its normal operating position before switching on.

POLE MOUNTED HEDGE TRIMMER SAFETY INSTRUCTIONS

1. Keep all parts of the body away from the cutter blade. Do not remove cut material or hold material to be cut when blades are moving. Make sure the product is switched off when clearing jammed material. A moment of inattention while operating the product may result in serious personal injury.
2. Carry the product by the handle with the cutter blade stopped. When transporting or storing the product always fit the cutting device cover. Proper handling of the product will reduce possible personal injury from the cutter blades.
3. Hold the product by insulated gripping surfaces only, because the cutter blade may contact hidden wiring. Cutter blades contacting a "live" wire may make exposed metal parts of the product "live" and could give the operator an electric shock.
4. Check the hedge for foreign objects before operation, e.g. wire fences.
5. Hold the product properly, e.g. with both hands if two handles are provided. Loss of control can cause personal injury.
6. Beware of overhead power lines. Do not use the product in any position that causes any part to come within 10m of overhead electrical lines.

FUEL HANDLING

1. Always disconnect the spark plug connector and let the product cool down, before refuelling it. Petrol is easily flammable. Never smoke when you are refuelling the product. Do not refuel the product, if there is an open fire in the vicinity!
2. Always use suitable aids such as funnels and filler necks. Do not spill any fuel on the product or its exhaust system. There is a risk of ignition. Remove spilled fuel carefully from all parts of the product. Any residue which may be present must have completely volatilised, before the product is put into operation!
3. Never use the product in environments where there is a risk of explosion. Exhaust gases and fuel fumes are noxious. Fuel fumes can ignite.
4. Never breathe in any fuel fumes, when you are refuelling the product. Never fill the tank in enclosed spaces, such as basements or sheds. There is a risk of poisoning and explosion!
5. Avoid skin contact with petrol.
6. Do not eat or drink, while you are refuelling the product. If you have swallowed petrol or oil, or if petrol or oil has got into your eyes, then seek the advice of a doctor immediately.
7. Close the tank lid immediately after filling the tank. Make sure that it is properly closed.
8. Never use the product without an air filter.

EMERGENCY

Familiarise yourself with the use of this product by means of this instruction manual. Memorise the safety directions and follow them to the letter. This will help to prevent risks and hazards.

1. **Always be alert when using this product, so that you can recognise and handle risks early.** Fast intervention can prevent serious injury and damage to property.
2. **Stop the engine and unplug the spark plug connector if there are malfunctions.** Have the product checked by a qualified professional and repaired, if necessary, before you operate it again.
3. **In case of fire stop the engine and unplug the spark plug connector.** Take fire-extinguishing measures immediately if the product switch is no longer accessible.



WARNING! Never use water to extinguish a product on fire. Burning fuel must be extinguished with special extinguishing agents. We recommend that you keep a suitable fire extinguisher within reach in your work area!

RESIUAL RISKS



WARNING! Even if you are operating this product in accordance with all the safety requirements, potential risks of injury and damage remain. The following dangers can arise in connection with the structure and design of this product:

1. Health defects resulting from vibration emission if the product is being used over long periods of time or not adequately managed and properly maintained.
2. Injuries and damage to property due to broken accessories or the sudden impact of hidden objects during use.
3. Danger of injury and property damage caused by flying objects.
4. Burns, if touching hot surfaces.
5. Prolonged use of this product expose the operator to vibrations and may produce 'whitefinger' disease. In order to reduce the risk, please wear gloves and keep your hands warm. If any of the 'whitefinger' symptoms appear, seek medical advice immediately. 'Whitefinger' symptoms include: numbness, loss of feeling, tingling, pricking, pain, loss of fingers, hands or wrists. The risk increases at low temperatures.



WARNING! This product produces an electromagnetic field during operation! This field may under some circumstances interfere with active or passive medical implants! To reduce the risk of serious or fatal injury, we recommend persons with medical implants to consult their doctor and the medical implant manufacturer before operating this product!

VIBRATION

The European Physical Agents (Vibration) Directive has been brought in to help reduce hand arm vibration syndrome injuries to power tool users. The directive requires power tool manufacturers and suppliers to provide indicative vibration test results to enable users to make informed decisions as to the period of time a power tool can be used safely on a daily basis and the choice of tool.

Further Advice can be found at www.hse.gov.uk

Vibration:

Vibration total values (triax vector sum) determined according to EN ISO 11806, EN ISO 10517	
Grass trimmer operation	
Left handle (at idling)	Vibration emission value $a_h = 3.192\text{m/s}^2$ Uncertainty $K = 1.5 \text{ m/s}^2$
Left handle (at racing)	Vibration emission value $a_h = 8.935\text{m/s}^2$ Uncertainty $K = 1.5 \text{ m/s}^2$
Reft handle (at idling)	Vibration emission value $a_h = 2.475\text{m/s}^2$ Uncertainty $K = 1.5 \text{ m/s}^2$
Reft handle (at racing)	Vibration emission value $a_h = 9.839\text{m/s}^2$ Uncertainty $K = 1.5 \text{ m/s}^2$
Hedge trimmer operation	
Left handle (at idling)	Vibration emission value $a_h = 6.477\text{m/s}^2$ Uncertainty $K = 1.5 \text{ m/s}^2$
Left handle (at racing)	Vibration emission value $a_h = 17.373\text{m/s}^2$ Uncertainty $K = 1.5 \text{ m/s}^2$
Reft handle (at idling)	Vibration emission value $a_h = 4.960\text{m/s}^2$ Uncertainty $K = 1.5 \text{ m/s}^2$
Reft handle (at racing)	Vibration emission value $a_h = 16.695\text{m/s}^2$ Uncertainty $K = 1.5 \text{ m/s}^2$

The declared vibration emission value should be used as a minimum level and should be used with the current guidance on vibration.

Calculating the actual period of the actual period off use can be difficult and the HSE website has further information.

The declared vibration emission been measured in accordance with a standard listed test stated above and may be used to compare one tool with another. The declared vibration emission value may also be used in a preliminary assessment of exposure.



WARNING! The vibration emission value during actual use of the power tool can differ from the declared value depending on the ways in which the tool is used dependant on the following examples and other variations on how the tool is used:

How the tool is used and the materials being ground or cut.
The tool being in good condition and well maintained.
The use of the correct accessory for the tool and ensuring it is sharp and in good condition.
The tightness of the grip on the handles.
And the tool is being used as intended by its design and these instructions.

This tool may cause hand-arm vibration syndrome if its use is not adequately managed.



WARNING! Identify safety measures to protect the operator that are based on an estimation of exposure in the actual conditions of use (taking account of all parts of the operating cycle such as the times when the tool is switched off and when it is running idle in addition to the trigger time). Note The use of other tools will reduce the users' total working period on this tool.

Helping to minimise your vibration exposure risk.

Maintain this tool in accordance with these instructions and keep well lubricated (where appropriate).

Avoid using tools in temperatures of 10°C or less.

Plan your work schedule to spread any high vibration tool use across a number of days.
Health Surveillance.

Health Surveillance.

All employees should be part of an employer's health surveillance scheme to help identify any vibration related diseases at an early stage, prevent disease progression and help employees stay in work.

SYMBOLS



Warning



Read the instruction manual



Compliance with relevant safety standards



Wear ear protection
Wear eye protection
Wear safety helmet!



Wear respiratory protection



Wear face protection!



Gloves with saw protection



Wear safety footwear



Wear protective clothing



Objects thrown by the product could hit the user or other bystanders. Always ensure that other people and pets remain at a safe distance from the product when it is in operation. In general, children must not come near the area where the product is. Minimum distance 15 m.



Always beware of the danger from overhead electric-power line, keep a safe distance at least 15M from the power line.



Risk of fire / flammable materials



Hot surface, do not touch. The high temperatures on the product's surfaces and structural parts could cause burns if touched. The product can also remain hot for a long period of time after operation!



This product produces noxious exhaust fumes. If the product is not used properly, these fumes can lead to poisoning, a loss of consciousness or death!



Warning! Switch the product off and disconnect the spark plug connector before assembly, cleaning, adjustments, maintenance, storage and transportation.



Only use petrol/oil mixture with a ratio of 40:1. Do not use any other mixture ratio. Always switch the product off and let it cool down, before refuelling it.



Naked flames in the work area, around the product and in the vicinity of flammable materials are prohibited!



Do not smoke in the work area, around the product and in the vicinity of flammable materials!



Maximum rotational frequency of the shaft for the cutting attachment in min^{-1}



Inspect the area where the product is to be used and remove all objects which can be thrown by the product. If objects are hidden while operating stop the engine and remove the object.



Do not use metal blades



Use a line spool only.



Location of starter handle: pull upwards



Do not touch the cutting device until it stops completely.



Guaranteed sound power level



Risk of long hair being drawn into air inlet.



Risk of loose clothing being drawn into air intake.

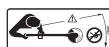

Keep other people out of working area during operation. A distance of at least 15 m must be observed.



Press the primer bulb.



Choke-Close position

Choke-Open position

A

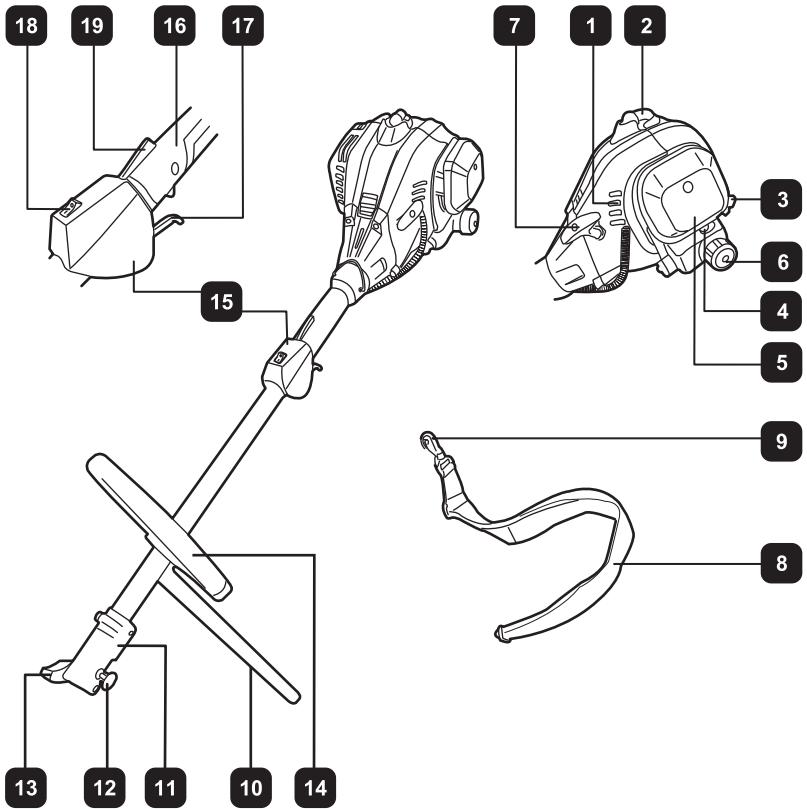

25CC PETROL MULTI TOOL TTL488GDO

A. Main unit

-
- 1 Air vents**

 - 2 Spark plug connector**

 - 3 Choke lever**

 - 4 Primer**

 - 5 Air filter case**

 - 6 Fuel tank cap**

 - 7 Recoil starter handle**

 - 8 Harness**

 - 9 Securing clip**

 - 10 Step guard**

 - 11 Clamp**

 - 12 Locking pin**

 - 13 Locking knob**

 - 14 Auxiliary handle**

 - 15 Control unit**

 - 16 Handle grip**

 - 17 Throttle trigger**

 - 18 Ignition switch on/off**

 - 19 Throttle interlock**

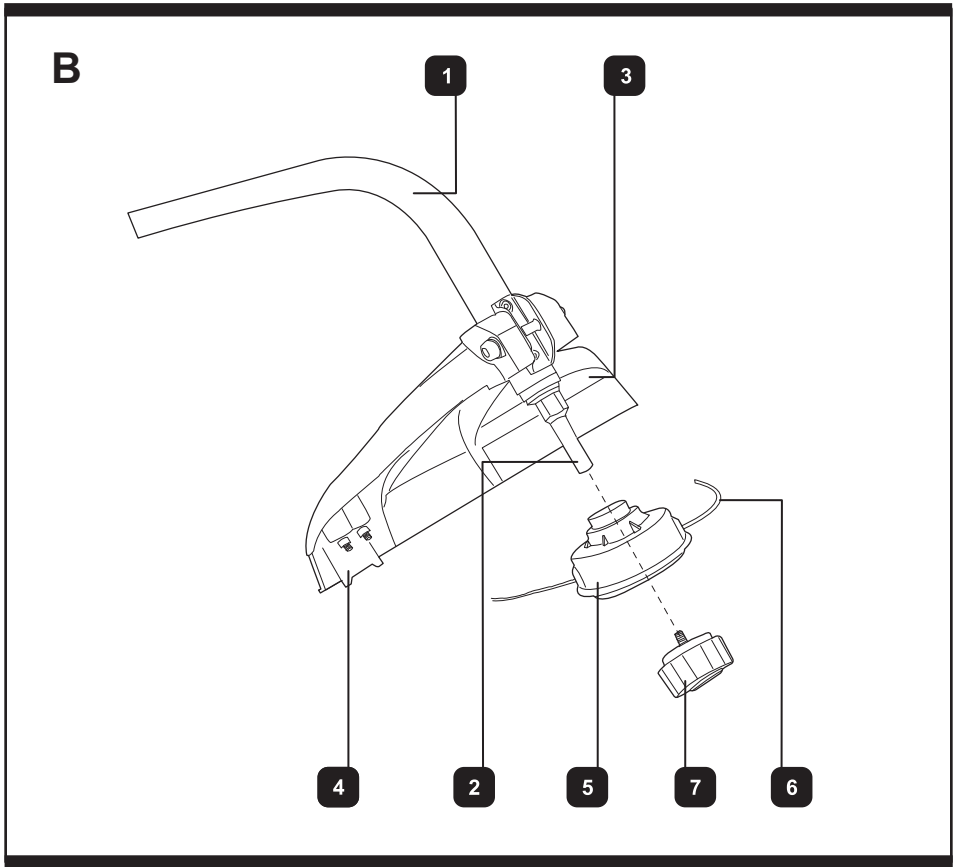

B. Grass trimmer

-
- | | |
|---|-------|
| 1 | Shaft |
|---|-------|
-
- | | |
|---|---------|
| 2 | Spindle |
|---|---------|
-
- | | |
|---|----------------|
| 3 | Trimming guard |
|---|----------------|
-
- | | |
|---|-------------|
| 4 | Line cutter |
|---|-------------|
-
- | | |
|---|--------------|
| 5 | Trimmer head |
|---|--------------|
-
- | | |
|---|---------------|
| 6 | Trimming line |
|---|---------------|
-
- | | |
|---|--------|
| 7 | Bumper |
|---|--------|
-

C

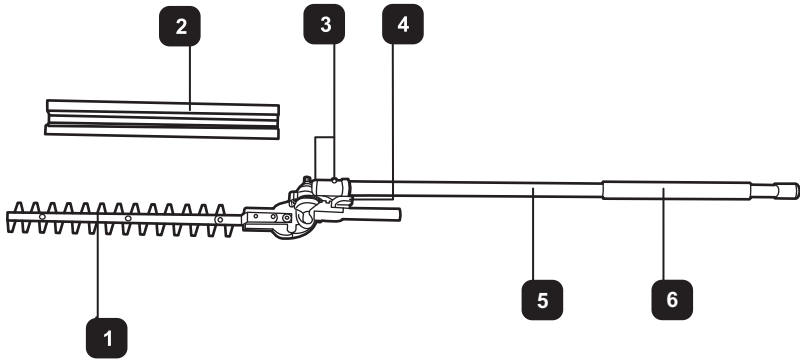

C. Hedge trimmer attachment

-
- 1 Hedging blade**

 - 2 Blade protection sheath**

 - 3 Bolts**

 - 4 Unlock levers**

 - 5 Hedge trimmer shaft**

 - 6 Gripping surface**

D

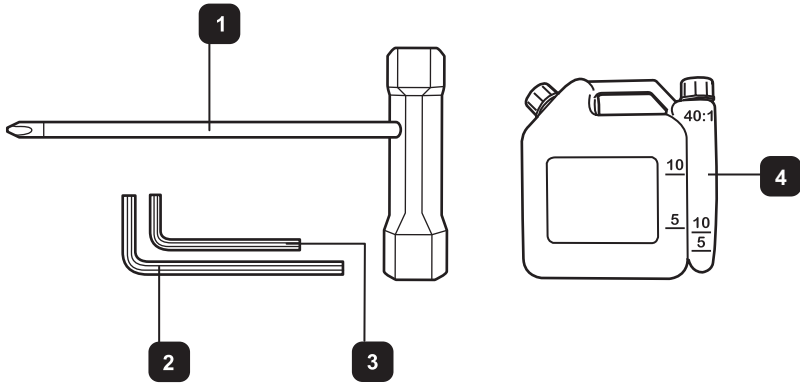

D. Tools

-
- 1 Multi tool I: Cross-head screw driver / socket wrench**

 - 2 Hex key 5 mm**

 - 3 Hex key 4 mm**

 - 4. Fuel/Oil mixing bottle**

25CC PETROL MULTI TOOL TTL488GDO

OPERATION INSTRUCTIONS



WARNING! Read all instructions carefully. Do not connect the spark plug before it is completely assembled. Always use gloves during assembly.

INTENDED USE

1. This 2 in 1 petrol multi tool is designated with an engine displacement of 25CC. Depending on the attached accessory this product is intended to be used as:
 - 1). **Grass trimmer:** With the line spool attached the product is intended to cut smaller types of weed, lawn grass or similar soft vegetation. It must not be used to work on unusually thick, dry or wet grass, e.g. pasture grass, or to shred leaves.
 - 2). **Pole hedge trimmer:** With the hedge trimmer blade attached the product is intended for trimming wide and high hedges, bushes and shrubs.
2. The product must not be used for cutting other materials, such as plastic, stone, metal or wood that contains foreign objects.
3. Observe the technical data for the maximum cutting capacity according to the application (see "**Technical data**"). Do not cut plants exceeding the stated maximum capacity.
4. This product is intended for private domestic use only, not for any commercial trade use. It must not be used for any purposes other than those described.

UNPACK

1. Unpack all parts and lay them on a flat, stable surface.
2. Remove all packing materials and shipping devices if applicable.
3. Make sure the delivery contents are complete and free of any damage. If you find that parts are missing or show damage do not use the product but contact your dealer. Using an incomplete or damaged product represents a hazard to people and property.
4. Ensure that you have all the accessories and tools needed for assembly and operation. This also includes proper personal protective equipment.
5. Disconnect the spark plug connector from the spark plug.

ASSEMBLY INSTRUCTIONS



WARNING! Be careful with small parts that are removed during assembly or when making adjustments. Make sure you do not lose them.

1. AUXILIARY HANDLE ASSEMBLY

1). Loosen the outer pre-assembled screws on the auxiliary handle (A14).

NOTE: There are holes on the bottom side of the upper shaft above the clamp to adjust the position of the handle.

- 2). Align the step guard (A10) with the small screw to the desired hole on the shaft.
- 3). Place the handle onto the shaft from the top and secure it with the longer screws. Tighten them with the hex key (D3). (See Fig. 1)

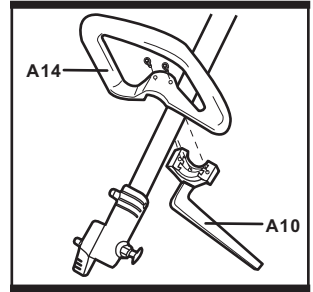

Fig. 1

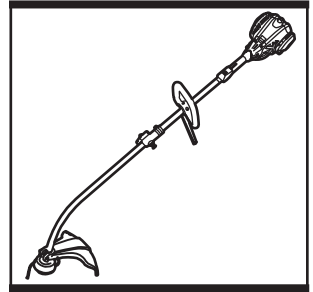

Fig. 2

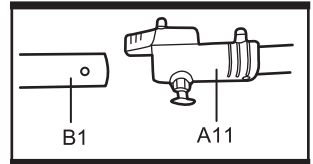

Fig. 3a

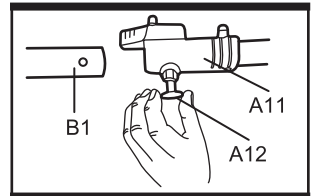

Fig. 3b

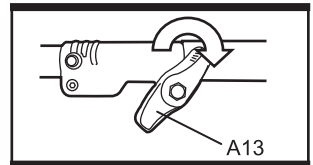

Fig. 3c

2. ASSEMBLE ATTACHMENTS TO SUIT THE INTENDED APPLICATION



WARNING! Read all the instructions carefully! Do not start the product until it is completely assembled! Always wear gloves during assembly!

This product can be used with different cutting heads for different applications. Follow the assembly steps for respective application.

Grass trimmer

With the grass trimmer head and its relative attachments correctly assembled, the product can be used as a grass trimmer intended to cut smaller types of weed, lawn grass or similar soft vegetation. (See Fig. 2)

- 1). Fit the grass trimmer shaft (B1) to the main unit.
 - a). Align the shaft(B1) with the clamp (A11) so that the hole in the shaft(B1) is orientated to the locking pin. (See Fig. 3a)
 - b). Pull out the locking pin (A12) and insert the shaft(B1) into the clamp (A11). Rotate the shaft slightly to let the locking pin engage in the hole. Release the locking pin and ensure it engages in the hole. (See Fig. 3b)
 - c). Secure the connection by tightening the locking knob (A13) clockwise. (See Fig. 3c)

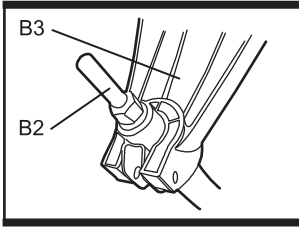

Fig. 4a

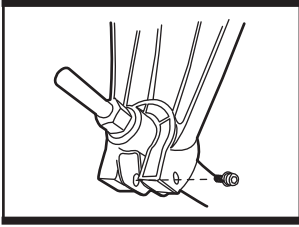

Fig. 4b

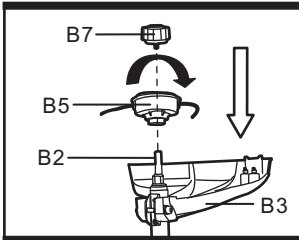

Fig. 5

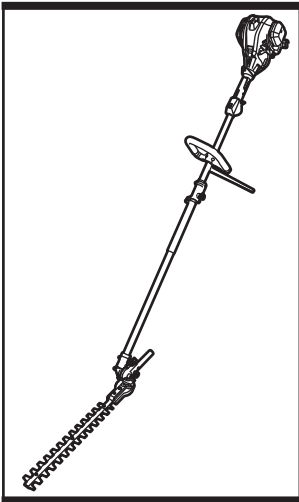

Fig. 6

2). Safety guard assembly



WARNING! Take great care when fitting the guard. The guard is fitted with a very sharp cutting edge. Please note for your safety the cutting edge is covered with a blade cover.

- a). Remove the bolt and screw nut on the guard (B3).
 - b). Place the guard over the end of the spindle (B2) and align the holes in the front of the guard with the slots in the bracket on the shaft. (See Fig. 4a)
 - c). Insert and secure the guard by the bolt and screw nut. Use a hex key to secure the bolt. (See Fig. 4b)
- 3). Grass trimmer head assembly
 - a). Make sure that the trimming guard (B3) has been attached properly.
 - b). Attach the trimmer head (B5) onto the spindle (B2).
 - c). Secure the trimmer head (B5) with bumper (B7) clockwise. (See Fig. 5)

Pole hedge trimmer

With the hedge trimmer blade and its relative attachments correctly assembled, this product can be used as pole hedge trimmer intended for trimming wide and high hedges, bushes and shrubs. (See Fig. 6)

Fit the hedge trimmer shaft directly to the upper shaft.
(See Fig.7)

3. FUEL AND ENGINE OIL

This product is equipped with a 2-stroke engine, the fuel and oil tank are combined and it's essential to fill a fuel oil mixture before operating this product. Observe the technical specifications for suitable fuel and engine oil.



WARNING! This product is not supplied with fuel-oil mixture in the engine! Before operating this product it is essential to fill it with fuel!



WARNING! Fuel and oil are highly inflammable! Fumes will explode if lit! Ensure that there are no naked flames around the product! Do not smoke while filling fuel and oil!

- 1). Place the product on a stable, level surface. We recommend laying a non-flammable sheet under the product.
- 2). Mix a regular-grade unleaded petrol and a quality mineral type oil for air cooled 2 stroke engines in a suitable container.
- 3). Use an anti-oxidant added quality oil expressly labelled for air-cooled 2 stroke engine use (JASO FC GRADE OIL or ISO EGC GRADE). Do not use BIA or TWC (2 stroke water-cooling type) mixed oil.
- 4). The recommended mixing ratio for petrol : oil is 40:1.
(See Fig. 8a)
- 5). Unscrew and remove the fuel tank cap (A6).
- 6). Fill correctly mixed fuel/oil into the tank using a fuel funnel (NOT SUPPLIED) fitted with a filter to avoid debris entering the tank. Do not overfill. Leave a minimum 5 mm of space between the top of the fuel and the inside edge of the tank to allow for expansion. (See Fig. 8b, 8c)
- 7). Avoid spilling and overfilling the tank.
- 8). Wipe up spilled fuel with a soft cloth and refit the fuel tank cap (A6).
- 9). Always dispose of excess fuel, used oil and soiled objects according to local regulations (see section "**Environmental Protection**").

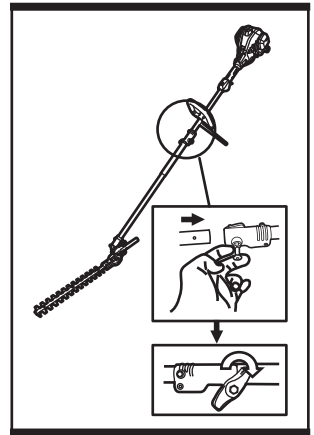

Fig. 7

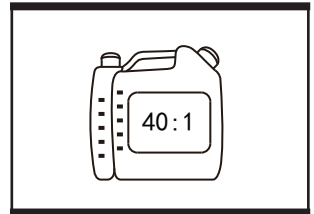

Fig. 8a

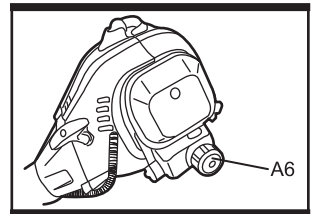

Fig. 8b

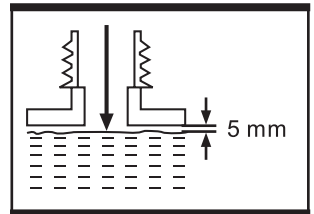

Fig. 8c

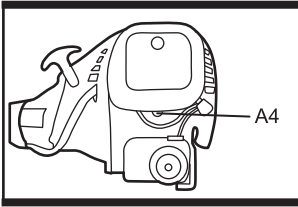

Fig. 9

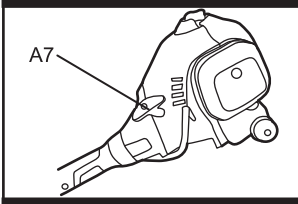

Fig. 10

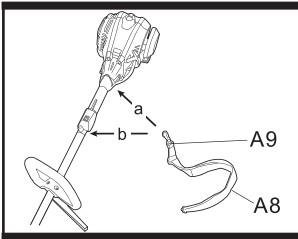

Fig. 11a

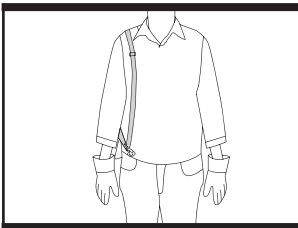

Fig. 11b

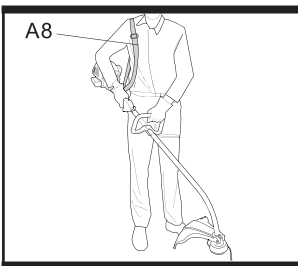

Fig. 11c

NOTE: Fuel and oil deteriorate over time. It may be difficult to start the engine if you use fuel which has been kept for more than 30 days. Towards the end of the season, it is advisable to put only as much fuel in the tank as you need for each mowing of the lawn, since it should be completely used up before storing the product. Empty remaining fuel from the tank when storing the product for over 30 days.

OPERATING INSTRUCTIONS

1. PRIMER

Press the primer (A4) 6 times when starting the product with a cold engine. Do not press the primer for the warm start. (See Fig. 9)

2. RECOIL STARTER

Pull on the recoil starter handle (A7) to start the engine. (See Fig. 10)



WARNING! Do not suddenly release the recoil starter handle! Always allow it to return under controlled tension!

3. HARNESS

The harness (A8) helps the operator carry this product.



WARNING! Always attach the product to the harness. Do not carry it just by hand!

- 1). To remove the harness from the loop (position a, b), open the securing clip (A9). (See Fig. 11a)
- 2). Place the harness so that it runs over the right shoulder, NOT crossing the chest and back. The securing point must be located at the right hip. (See Fig. 11b)
- 3). Adjust the length of the harness (A8) so that the hook is approximately 15 cm below your waist; locate the product to the harness by using the securing clip ensuring that the angle of the cutting head is approximately 30° to the surface being cut. (See Fig. 11c)



WARNING! When operating with the grass trimmers attachment, the harness MUST be located on the rear loop (position a). When using the hedge trimmer attachment, the harness can be located on either loop, depending on comfort.



WARNING! Always attach the product to the harness. Do not carry it only with your hands.

- 4). In case of emergency, throw the product away from the operator.

4. AUXILIARY HANDLE

Adjust the position of the auxiliary handle (A14) on the upper shaft.

- 1). Loosen the bolts on the auxiliary handle (A14) and adjust the position. (See Fig. 12)
- 2). Afterward tighten the bolts.

5. STARTING AND STOPPING

This product is controlled by the control handle. For operation three steps are necessary: Firstly, the ignition switch (A18) must be put into its on position "I". Then the throttle interlock (A19) must be pressed to disengage the throttle trigger. Finally press the throttle trigger (A17). (See Fig. 13a)

1). Cold Start

- a). Place the product on a flat, stable surface. Ensure that the attachment in use does not touch the ground or any objects.
- b). Set the ignition switch (A18) to its on position "I". (See Fig. 13b)
- c). Move choke lever (A3) to position **I**.
- d). Pull the recoil starter handle (A7) firmly; repeat until the engine starts. (See Fig. 13e) depress the primer (A4) 6 times until fuel is visible. (See Fig. 13c)
- e). Move the choke lever (A3) to position **II**, allow the product to run at idle speed for 30 seconds to let it warm up.
- f). Once the engine is running correctly, carefully lift the product and securely hold it by its handles.



WARNING! Make sure that the cutting blade is not touching the ground or other objects when starting the product! Allow the recoil starter rope to return slowly and controlled after each pull!

2). Warm Start

- a). Place the product on a flat, stable surface. Ensure that the attachment in use does not touch the ground or any objects.
- b). Set the ignition switch (A18) to its on position "I". (See Fig. 13b)
- c). Move the choke lever (A3) to the position **II**. Do not press the primer. (See Fig. 13d)
- d). Pull the recoil starter handle (A7) firmly; repeat until the engine starts. (See Fig. 13e)

NOTE: During idle running the cutting blade should not move. Contact a qualified technician if you find that the cutting blade is moving.

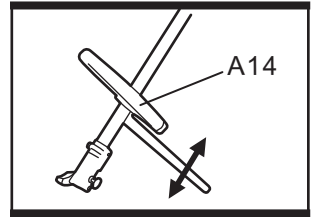

Fig. 12

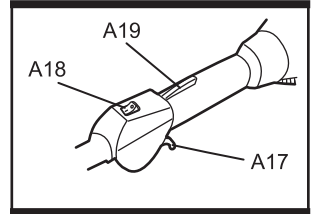

Fig. 13a

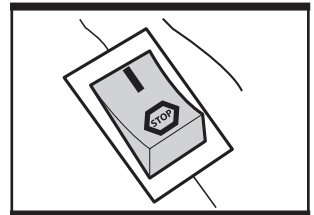

Fig. 13b

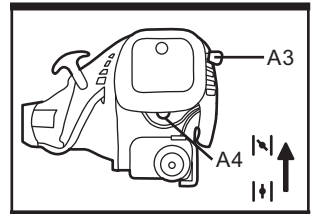

Fig. 13c

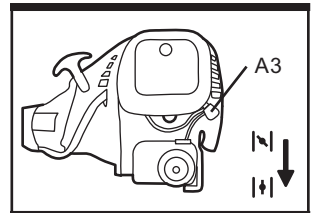

Fig. 13d

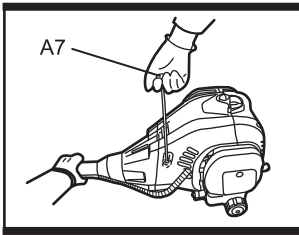

Fig. 13e

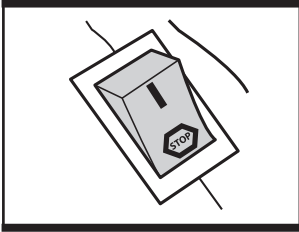

Fig. 14

2). Operation

- a). Press the throttle interlock (A19), hold it in position and then press the throttle trigger (A17) to engage the attachment.
- b). Release the throttle trigger (A17), this tool will be set at idle speed status.

3). Stopping

- a). Release the throttle trigger (A17) and let the product run at its idle speed for 10-15 seconds.
- b). Set the ignition switch (A18) to its off position "STOP". (See Fig. 14)



WARNING! The attachment will continue to move for some time even after the engine has been switched off! Wait until the attachment has come to a complete stop before placing the product on the ground!

6. GENERAL BEHAVIOUR

- 1). Check the product as well as accessories for damage before each use. Do not use the product if it is damaged or shows wear.
- 2). Double check that accessories, safety guards and trimmer head are properly fixed.
- 3). Always hold the product by its handles. Keep the handles dry to ensure safe support.
- 4). Ensure that the air vents are always unobstructed and clean. Clean them if necessary with a soft brush. Blocked air vents may lead to overheating and damage the product.
- 5). Switch the product off immediately if you are disturbed while working with it and when other people enter the working area. Always let the product come to complete stop before putting it down.
- 6). Do not overwork yourself. Take regular breaks to ensure you can concentrate on the work and have full control over the product.

7. GRASS TRIMMER

- 1). Use the trimmer head (B5) to cut smaller types of weed, lawn grass or similar soft vegetation.
- 2). Remove the protection cap from the line cutter (B4).
- 3). Hold the product firmly so that it sits with a gap between the product and your right side.
- 4). Stand upright, do not lean forward and pay attention to posture. Keep both feet apart to help retain your balance.
- 5). Hold the trimmer head just above the ground at an angle of approximately 30°. (See Fig. 15a)
- 6). Move the product with slow and regular arc from left to right before moving it back to the starting position before trimming the next area. (See Fig. 15b)
- 7). Ensure the cutting head remains clean and free from off-cuts that may cause it to jam. Check regularly. Stop the engine, switch the ignition switch (A18) to "STOP" and remove the spark plug connector (A2) before checking.
- 8). Trim longer grass in stages, do not cut long grass in one cut. For the best results, cut longer grass in steps. (See Fig. 15c, 15d)
- 9). The trimmer head is equipped with a bumper (B7) helping to cut the trimming line (B6) while operating. Simply tap the bumper on a firm surface and the spool will release fresh trimming line. (See Fig. 15e)
- 10). A line cutter (B4) is integrated with the trimming guard (B3) and this will cut the line to the necessary length. (See Fig. 15f)



WARNING! The cut line will be thrown out!
Danger of injury especially for bystanders!

- 11). For best results, do not cut wet grass because it tends to stick to the cutting heads and guard, prevents proper discharge of grass trimmings, and could cause you to slip and fall.

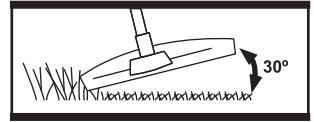

Fig. 15a

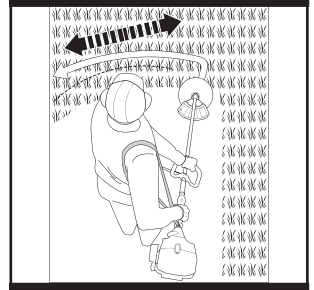

Fig. 15b

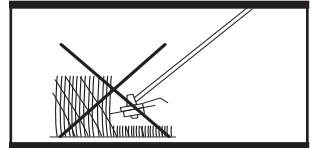

Fig. 15c

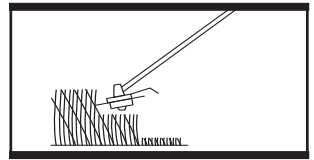

Fig. 15d

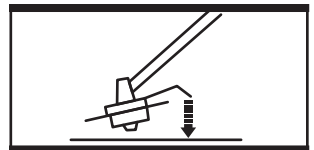

Fig. 15e

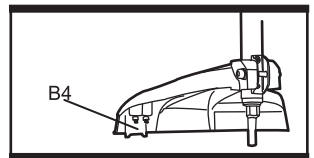

Fig. 15f

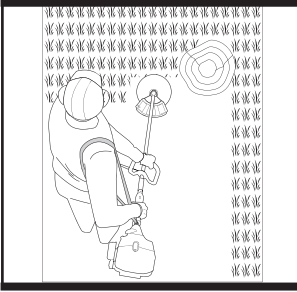

Fig. 15g

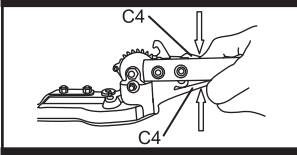

Fig. 16a

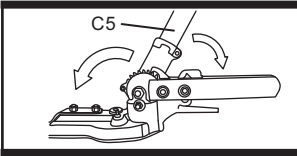

Fig. 16b

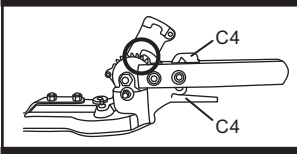

Fig. 16c

12). Pay special attention when performing the work close to trees and bushes. The cutting heads could damage sensitive bark, and damage fence posts. (See Fig. 15g)

8.HEDGE TRIMMER

1). Angle adjustment

Adjust the attachment angle to fit the growth of the plant.

- a). Depress the unlock levers (C4) with one hand and hold them in position. (See Fig. 16a)
- b). Move the hedge trimmer shaft (C5) with the other hand until the desired angle is adjusted. (See Fig. 16b)
- c). Release the unlock levers (C4) when the desired angle is adjusted. Ensure that the hook engages between two teeth of the tooth wheel. (See Fig. 16c)

2). Trimming

- a). Prepare the product to required length attaching the hedge trimmer shaft.
- b). Cut and remove branches exceeding the cutting capacity of this product using a proper pruner before operation.
- c). Always hold the product firmly with both hands on gripping surface and handle grip (A17). Never operate this product using only one hand.

d). Cut both sides from the bottom cutting upwards to the top. This will prevent any of the cuttings falling into the path of the area still to be cut. (See Fig. 17a)

e). After cutting the sides proceed to the top.

f). When cutting wide hedges with the cutting area in sight move the cutting blade lightly through the cutting surface in a sweeping motion following the shape of the hedge or shrub. A slight tilt downwards of the cutting blade in the direction of motion is recommended for optimum cutting performance. (See Fig. 17b)

g). Move the product with slow motion forward when cutting higher hedge and the cutting area out of sight. (See Fig. 17c)

h). Do not to rush and do not attempt to cut too much with one stroke of the cutting blade.

l). Cut in a number of stages if the area being cut is particularly long to achieve better result; smaller cuttings will allow for easy composting.

NOTE: Try to keep the cutting blade angled at approximately 15° to the cutting surface.

NOTE: When shaping it is advisable to achieve a trapezoidal shape (See Fig. 17d). A trapezoidal cut corresponds to the natural growth of plants and results in optimal hedge growth, as it will expose more light to the bottom of the hedge.

9.AFTER USE

1). Switch the product off, allow the engine to cool down and then remove the spark plug connector.

2). Check, clean and store the product as described below.



Fig. 17a



Fig. 17b



Fig. 17c

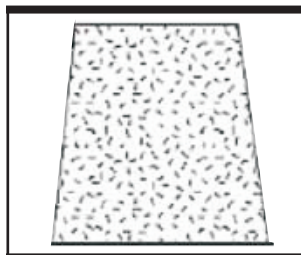

Fig. 17d

MAINTENANCE



WARNING! Always switch the product off, let the product cool down and disconnect the spark plug connector before performing inspection, maintenance and cleaning work!



WARNING! Only perform repairs and maintenance work according to these instructions! All further works must be performed by a qualified specialist!



WARNING! Wear safety gloves when working on the attachment heads and close to it! Use appropriate tools to remove debris, e.g. a brush or wooden stick! Never use your bare hands!

Keep the product clean. Remove debris from it after each use and before storage. Regular and proper cleaning will help ensure safe use and prolong the life of the product. Inspect the product before each use for worn and damaged parts. Do not operate it if you find broken and worn parts.

GENERAL CLEANING

NOTE: Do not use chemical, alkaline, abrasive or other aggressive detergents or disinfectants to clean this product as they might be harmful to its surfaces.

1. Clean the product with a slightly damp cloth and mild soap. Use a brush for areas that are hard to reach.
2. In particular clean the air vents after every use with a cloth and brush.
3. Remove stubborn dirt with high pressure air (max. 3 bar).
4. Check for worn or damaged parts. Replace worn part as necessary or contact an authorised service centre for repair before using the product again.

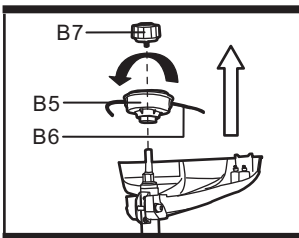

Fig. 18b

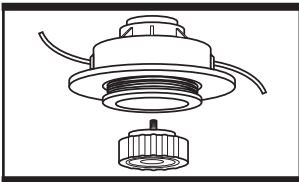

Fig. 18b

TRIMMER HEAD

1. Keep the trimmer head (B5) clean and free of debris. Remove trimmings.
2. If the line is used up the spool must either be replaced by one of the same type or the trimming line (B6) must be refilled.
3. To refill the trimming line lay the product on a flat stable surface with its trimmer head facing upwards.
4. Remove the trimmer head (B5) by unscrewing anticlockwise the bumper (B7). (See Fig. 18a)
5. To replace the spool simply remove from the trimmer head (B5) and replace with a new one of the same type. (See Fig. 18b)

6. To replace the trimming line, press the release latch of the trimmer head housing to open the cover.
7. Cut a new 6 m long trimming line with a diameter of 2mm. Form a loop at the middle of the line and insert this loop into the hook on the spool. (See Fig. 18c)
8. Wind the two parts of the trimming line in clockwise direction firmly around the spool each part in the guide on the spool. (See Fig. 18d)
9. Insert each end of the threads in the respective holes.
10. Screw the bumper (B7) clockwise until it is completely and safely locked.



WARNING! After changing the trimming line, run the product under no load for at least a minute to make sure that the line and the product are operating correctly! **WARNING!** Never use steel thread! Always use cutting means in perfect condition, free of damage!

BLADE (HEDGE TRIMMER)

1. Keep the hedging blade (C1) clean and free of debris. Remove trimmings.
2. Keep the hedging blade (C1) sharp to retain a good cutting performance. Replace a worn or damaged cutting blade with a new one of the same type.
3. Lubricate the hedging blade (C1) after each use to prolong the life span of cutting blade and product. Apply light machine oil along the edge of the cutting blade.

AIR FILTER

1. Inspect the air filter regularly. Replace it with a new one if necessary.
2. Open the air filter case (A5) with the cross-head screwdriver (D1), and remove the filter. (See Fig. 19)
3. Tap the filter on a stable surface to remove dust. Use compressed air (max. 3 bar) to remove stubborn dust.
4. Apply a small amount of air filter oil on the filter to increase the filter performance. Wring out surplus oil and put the filter into the case ensuring correct alignment of the filter foam in the housing.
5. Close the air filter cover.

FUEL TANK

1. Empty the fuel tank when storing the product over 30 days to prevent the fuel from deteriorating.
2. Unscrew and remove the fuel tank cap (A6) and use a proper fuel pump to empty the fuel into a suitable container.

FUEL FILTER

The fuel tank of this product is fitted with a filter located at the free end of the fuel pipe. Ask an authorised service centre or similar qualified person to check and where necessary replace it at regular intervals.

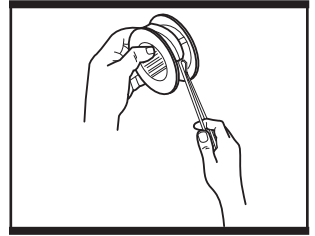

Fig. 18c

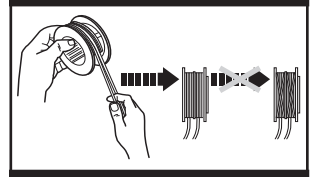

Fig. 18d

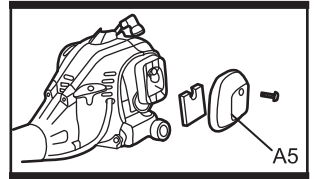

Fig. 19

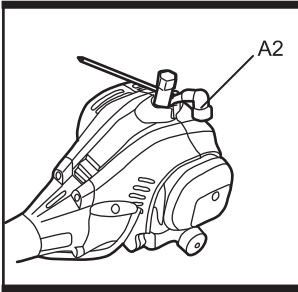

Fig. 20a

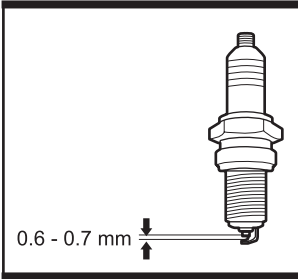

Fig. 20b

SPARK PLUG

NOTE! This engine uses a CHAMPION RCJ6Y spark plug with 0.6-0.7mm electrode gaps. Use a suitable replacement and replace once a year. You can it replace with "CHAMPION" or "NGK" as an alternative.

1. Inspect the spark plug at least every 25 hours or prior to long-term storage over 30 days if the use has not been this high. Clean or replace with a new spark plug if necessary.
2. Unplug the spark plug connector (A2). Loosen the spark plug with the socket wrench (D1) anticlockwise and carefully remove it. (See Fig. 20a)
3. Check the spark plug for damage and wear. The colour of the electrode should be light-brown coloured.
4. Remove debris from the electrode with a soft wired brush; avoid heavy cleaning of the electrode.
5. Dry the spark plug with a soft cloth if it is wet from fuel.
6. Check the spark plug gap; it should be 0.6 - 0.7 mm. (See Fig. 20b)
7. Replace with a new spark plug if either the electrode or the insulation is damaged.
8. When replacing the spark plug, first screw it in hand tight and then lightly tighten it with the socket wrench.



WARNING! Do not over-tighten the spark plug to avoid any damage!

BEVEL GEAR(HEDGE TRIMMER)

The bevel gear is filled with grease. Ask an authorised service centre or similar qualified person to check the quantity regularly and fill up using proper grease if necessary.

CARBURETTOR

The carburetor is pre-adjusted by the manufacturer. Should it be necessary to make any changes please contact an authorised service centre or a similarly qualified person. Do not attempt to make any adjustments by yourself.

REPAIR

This product does not contain any parts that can be repaired by the consumer. Contact a qualified specialist to have it checked and repaired.

STORAGE

1. Clean the product as described above.
2. Store the product and its accessories in a dry, frost-free, well-ventilated place.
3. Always store the product in a place that is inaccessible to children. The ideal storage temperature is between 10 and 30°C.
4. We recommend using the original package for storage or covering the product with a proper cloth or enclosure to protect it against dust.

TRANSPORTATION

1. Switch the product off and disconnect the spark plug connector before transporting it anywhere.
2. Attach transportation guards for cutting means of hedge trimmer.
3. Always carry the product by its handles.
4. Protect the product from any heavy impact or strong vibrations which may occur during transportation in vehicles.
5. Secure the product to prevent it from slipping or falling over.

ENVIRONMENTAL PROTECTION

1. Waste products should not be disposed of with household waste. Please recycle where facilities exist. Check with your Local Authority or local store for recycling advice.
2. Petrol, oil, old oil, a mixture of oil and petrol and objects soiled with oil e.g. cleaning cloths do not belong in the household rubbish. Dispose of oily items in accordance with local guidelines and hand them in at recycling centres.
3. This product comes in a package that protects it against damages during shipping. Keep the packaging until you are sure that all parts have been delivered and the product is functioning properly. Recycle the packaging afterwards.

TROUBLESHOOTING



WARNING! Suspected malfunctions are often due to causes that the user can fix themselves. Therefore check the product using this section. In most cases the problem can be solved quickly.



WARNING! Only perform the steps described within these instructions! All further inspection, maintenance and repair work must be performed by an authorised service centre or a similarly qualified specialist if you cannot solve the problem yourself!

Problem	Possible cause	Fault correction
Engine does not start	Not enough fuel in the fuel tank	Add fuel
	Primer has not been pressed at cold start	Press the primer and restart
	Primer has been pressed at warm start	Dry spark plug
	Spark plug is wet	Dry spark plug
	Spark plug is damaged	Replace the spark plug
	Spark plug connector loose	Attach properly
Engine stops	Not enough fuel in the fuel tank	Add fuel
	Cutting device is blocked	Remove the blockage
Unsatisfactory cutting performance	Cutting blade is dull/damaged	Have a specialist to sharpen or replace it
	Cutting material exceeds capacity	Only cut materials acc. to the capacity of the product
Excessive vibration/ noise or is smoking excessively	Cutting device is dull/damaged	Replace with a new one replace it
	Bolts/nuts are loosen	Tighten bolts/nuts
	Petrol/oil is incorrect	Empty unused petrol/oil and refill with the correct petrol/oil

TECHNICAL DATA

GENERAL

Engine type	SL 33, air cooled 2-stroke
Engine displacement	25cc
Max. shaft break power	0.8 kW
Max. engine speed	10500 /min
Engine idle speed	3000 /min
Clutch engagement speed	4500 /min
Fuel tank volume	500 ml
Fuel type	#95 unleaded, in a 40:1 ratio mix with 2 stroke oil
Fuel consumption at maximum engine power	0.38 kg/h
Specific fuel consumption at maximum engine power	447 g/kWh
Engine oil type	2-cycle motor oil (2T FC)
Mixture ratio petrol : oil	40 : 1
Spark plug type	CHAMPION: RCJ6Y;NGK: BPMR7A
Spark plug gap	0.6 – 0.7 mm

GRASS TRIMMER

Line spool diameter	Ø 2mm
Max. cutting width	430 mm
Maximum rotational frequency of the spindle	7300 /min
Max. engine speed	10500 /min
Noise values	
Sound pressure level $L_{pA,ld}$	76.1 dB(A)
Sound pressure level $L_{pA,R}$	96.5 dB(A)
Sound pressure level $L_{pA,av}$	93.5 dB(A)
Uncertainty	3 dB(A)
Sound power level $L_{WA,m}$	109.7 dB(A)
Uncertainty	3 dB(A)
Guaranteed sound power level L_{WA}	112 dB(A)
Net weight (without grass trimmer attachments)	5.6kg

HEDGE TRIMMER

Max. cutting length	365 mm
Max. cutting capacity	24 mm
No-load speed	2500/min
Adjustable cutting angle range	-90° — +60°
Noise values	
Sound pressure level $L_{pA,ld}$	77.7 dB(A)
Sound pressure level $L_{pA,R}$	96.5 dB(A)
Sound pressure level $L_{pA,av}$	93.5 dB(A)
Uncertainty	3 dB(A)
Sound power level $L_{WA,ld}$	87.0 dB(A)
Sound power level $L_{WA,R}$	109.4 dB(A)
Sound power level $L_{WA,av}$	106.4 dB(A)
Uncertainty	3 dB(A)
Guaranteed sound power level L_{WA}	112 dB(A)
Net weight (without hedge trimmer attachments)	7.0kg

The sound intensity level for the operator may exceed 85dB(A) and ear protection measures are necessary.

The conformity assessment followed was according to Annex III of the directive for equipment listed in schedule 1 / article 13 the chosen conformity assessment route Internal control of production (schedule 10 / Annex V) - Guaranteed Sound Power Level 112 dB (A).

ACCESSORIES

HARNESS	1PC
MULTI TOOL	1PC
HEX KEY(4MM)	1PC
HEX KEY(5MM)	1PC
FUEL/OIL MIXING BOTTLE	1PC

25CC PETROL MULTI TOOL TTL488GDO



(EN) EU DECLARATION OF CONFORMITY
(FR) DÉCLARATION UE DE CONFORMITÉ
(PL) DEKLARACJA ZGODNOŚCI UE
(RO) DECLARAȚIA DE CONFORMITATE UE
(ES) DECLARACIÓN UE DE CONFORMIDAD
(PT) DECLARAÇÃO DE CONFORMIDADE UE

Product/ Produit/ Produkt/Produsul/Producto/Produto

- > Multi tool
- > TTL488GDO
- > 25 cm³ , 0.8 kW
- > 000001 - 999999

Name and address of the manufacturer or his authorised representative:

Nom et adresse du fabricant ou de son mandataire :

Nazwa i adres producenta lub jego upoważnionego przedstawiciela:

Denumirea și adresa producătorului sau a reprezentantului său autorizat:

Nombre y dirección del fabricante o de su representante autorizado:

Nome e endereço do fabricante ou do respetivo mandatário:

Kingfisher International Products B.V.,
Rapenburgerstraat 175E,
1011 VM Amsterdam,
The Netherlands
www.kingfisher.com/products

This declaration of conformity is issued under the sole responsibility of the manufacturer.

La présente déclaration de conformité est établie sous la seule responsabilité du fabricant.

Niniejsza deklaracja zgodności wydana zostaje na wyłączną odpowiedzialność producenta.

Prezenta declarație de conformitate este emisă pe răspunderea exclusivă a producătorului.

La presente declaración de conformidad se expide bajo la exclusiva responsabilidad del fabricante.

A presente declaração de conformidade é emitida sob a exclusiva responsabilidade do fabricante.

Object of the declaration/Objet de la déclaration/Przedmiot deklaracji/Obiectul declarației/Objeto de la declaración/Objeto da declaração

Product/Produit/Produkt/Produsul/Producto/Produto	Model/Modèle/Model/ Modelul/Modelo/ Modelo	EAN
Multi tool	TTL488GDO	5052931257119

The object of the declaration described above is in conformity with the relevant Union harmonisation legislation:

L'objet de la déclaration décrit ci-dessus est conforme à la législation d'harmonisation de l'Union applicable :

Wymieniony powyżej przedmiot niniejszej deklaracji jest zgodny z odnośnymi wymaganiami unijnego prawodawstwa harmonizacyjnego:

Obiectul declarației descris mai sus este în conformitate cu legislația relevantă de armonizare a Uniunii:

El objeto de la declaración descrita anteriormente es conforme con la legislación de armonización pertinente de la Unión:

O objeto da declaração acima descrito está em conformidade com a legislação de harmonização da União aplicável:

2006/42/EC as amended Machinery Directive
2014/30/EU as amended Directive Electromagnetic compatibility
2000/14/EC as amended Outdoor Noise Directive
2016/1628/EU Regulation Gaseous and Particulate Pollutant Emission Limits
2011/65/EU as amended Directive Restriction of the use of certain hazardous substances in electrical and electronic equipment
2006/42/CE telle que modifiée Directive sur les machines
2014/30/UE telle que modifiée Directive Compatibilité électromagnétique
2000/14/CE telle que modifiée Directive relative aux émissions sonores dans l'environnement des matériels destinés à être utilisés à l'extérieur des bâtiments
2016/1628/UE Règlement relatif aux exigences concernant les limites d'émission pour les gaz polluants et les particules polluantes
2011/65/UE telle que modifiée Directive relative à la limitation de l'utilisation de certaines substances dangereuses dans les équipements électriques et électroniques
2006/42/WE w zmienionej dyrektywie maszynowej
2014/30 / UE ze zmianami Dyrektywa Kompatybilność elektromagnetyczna
2000/14/WE w zmienionej dyrektywie w sprawie hałasu na zewnątrz
2016/1628/UE limity emisji zanieczyszczeń gazowych i cząstek stałych
2011/65 / UE ze zmianami Dyrektywa Ograniczenie stosowania niektórych niebezpiecznych substancji w sprzęcie elektrycznym i elektronicznym
2006/42/CE, astfel a fost modificată Directiva privind echipamentele
2014/30/UE, astfel a fost modificată Directiva privind compatibilitatea electromagnetică
2000/14/CE, astfel a fost modificată Directiva privind zgomotul în aer liber
2016/1628/UE Regulamentul privind emisiile de poluanți gazoși și de particule poluante
2011/65/UE, astfel a fost modificată Directiva privind limitarea utilizării anumitor substanțe periculoase în echipamentele electrice și electronice
Directiva sobre maquinaria modificada 2006/42/CE
2014/30/UE modificada Directiva Compatibilidad electromagnética
2000/14/CE modificada Directiva sobre ruido al aire libre
2016/1628/Reglamento de la UE Límites de emisiones de contaminantes gaseosos y partículas
2011/65/UE modificada Directiva Restricción del uso de determinadas sustancias peligrosas en equipos eléctricos y electrónicos
2006/42/CE como diretiva de máquinas alteradas
2014/30/UE como alteração da compatibilidade eletromagnético
2000/14/CE como diretiva de ruído exterior alterada
Limites de emissão de poluentes gasosos e de poluentes de partículas 2016/1628/REGULAMENTO da UE
2011/65/UE como restrição diretiva alterada da utilização de certas substâncias perigosas em equipamentos elétricos e eletrônicos

25CC PETROL MULTI TOOL TTL488GDO

Measured Sound Power Level

Le niveau de puissance acoustique mesuré

Zmierzony poziom mocy akustycznej

Nivel de putereacustică măsurat / Nivel de putereacustică garantat

Nível de potencia sonora medido

Nível de potência sonora medido

: 109.7 dB(A)

Engine Model

Modèle de moteur

Model silnika

Modelul motorului

Modelo de motor

Modelo de motor

: SL33

Guaranteed Sound Power Level

Le niveau de puissance acoustique garant

Gwarantowany poziom mocy akustycznej

Nível de potencia sonora garantizado

Nível de potência sonora garantido

: 112 dB(A)

References to the relevant harmonised standards used or references to the other technical specifications in relation to which conformity is declared:

Références des normes harmonisées pertinentes appliquées, y compris la date de celles-ci, ou des autres caractéristiques techniques, y compris la date de celles-ci, par rapport auxquelles la conformité est déclarée:

Odwolania do odnośnych norm zharmonizowanych, które zastosowano, wraz z datą normy, lub do innych specyfikacji technicznych, wraz z datą specyfikacji, w odniesieniu do których deklarowana jest zgodność:

Trimiteri la standardele armonizate relevante folosite, inclusiv data standardului, sau trimiteri la celelalte specificații tehnice, inclusiv data specificațiilor, în legătură cu care se declară conformitatea:

Referencias a las normas armonizadas pertinentes utilizadas, incluidas las fechas de las normas, o referencias a las otras especificaciones técnicas, incluidas las fechas de las especificaciones, respecto a las cuales se declara la conformidad:

Referências às normas harmonizadas aplicáveis utilizadas, incluindo a data da norma, ou às outras especificações técnicas, incluindo a data da especificação, em relação às quais é declarada a conformidade:

EN ISO 11806-1:2011

EN ISO 10517:2019

EN ISO 14982:2009

Authorised signatory and technical file holder/signataire et responsable de la documentation technique autorisé/podmiot uprawniony do wystawienia i adres przechowywania dokumentacji technicznej/semnatar autorizat și deținător al dosarului tehnic/firmante autorizado y titular del expediente técnico/signatário autorizado e detentor da ficha técnica

Kingfisher International Products B.V.,

Rapenburgerstraat 175E,

1011 VM Amsterdam,

The Netherlands

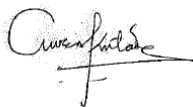

David Awe

Group Quality Director

:27/08/2021